

TECHNICAL REPORT



ISO/IEC17025 Accredited Lab.

Report No: FCC 1203056
File reference No: 2012-04-25

Applicant: FUJIAN NAN'AN BAOFENG ELECTRONICS CO., LTD

Product: Two Way Radio

Model No: UV-5R

Trademark: BAOFENG

Test Standards: FCC Part 90

Test result: It is herewith confirmed and found to comply with the requirements set up by ANSI C63.4 and FCC Part 90, regulations for the evaluation of electromagnetic compatibility

Approved By

Jack Chung

Jack Chung
Manager

Dated: April 25, 2012

Results appearing herein relate only to the sample tested

The technical reports is issued errors and omissions exempt and is subject to withdrawal at

SHENZHEN TIMEWAY TECHNOLOGY CONSULTING CO., LTD

5/F,Block 4, Anhua Industrial Zone.,No.8 TaiRan Rd.CheGongMiao,FuTian District, Shenzhen,CHINA.

Tel (755) 83448688

Fax (755) 83442996



Special Statement:

The testing quality ability of our laboratory meet with "Quality Law of People's Republic of China" Clause 19.

The testing quality system of our laboratory meet with ISO/IEC-17025 requirements, which is approved by CNAL. This approval result is accepted by MRA of APLAC.

Our test facility is recognized, certified, or accredited by the following organizations:

CNAL-LAB Code: L2292

The EMC Laboratory has been assessed and in compliance with CNAL/AC01:2002 accreditation criteria for testing Laboratories (identical to ISO/IEC 17025:1999 General Requirements) for the Competence of testing Laboratories.

FCC-Registration No.: 899988

The EMC Laboratory has been registered and fully described in a report filed with the (FCC) Federal Communications commission. The acceptance letter from the FCC is maintained in our files. Registration No.: 899988.

IC- Registration No.: IC5205A-01

The EMC Laboratory has been registered and fully described in a report filed with the (IC) Industry Canada. The acceptance letter from the IC is maintained in our files. Registration IC No.: 5205A-01.

The report refers only to the sample tested and does not apply to the bulk.

This report is issued in confidence to the client and it will be strictly treated as such by the Shenzhen Timeway Technology Consulting Co.,Ltd. It may not be reproduced rather in its entirety or in part and it may not be used for advertising. The client to whom the report is issued may, however, show or send it, or a certified copy thereof prepared by the Shenzhen Timeway Technology Consulting Co.,Ltd to his customer. Supplier or others persons directly concerned. Shenzhen Timeway Technology Consulting Co.,Ltd will not, without the consent of the client enter into any discussion of correspondence with any third party concerning the contents of the report.

In the event of the improper use of the report. The Shenzhen Timeway Technology Consulting Co.,Ltd reserves the rights to withdraw it and to adopt any other remedies which may be appropriate.



Test Report Conclusion
Content

1.0	General Details	4
1.1	Test Lab Details.....	4
1.2	Applicant Details.....	4
1.3	Description of EUT	4
1.4	Submitted Sample.....	4
1.5	Test Duration.....	4
1.6	Test Uncertainty.....	5
1.7	Test By.....	5
2.0	List of Measurement Equipment	5
3.0	Technical Details	7
3.1	Summary of Test Results.....	7
3.2	Test Standards.....	7
4.0	EUT Modification	7
5.0	Power Line Conducted Emission Test	8
6.0	Frequency Tolerance	12
7.0	Emission Bandwidth and Mask	17
8.0	Unwanted Radiation	37
9.0	Modulation Characteristics	44
10.0	Maximum transmitter Power (Conducted Output Power)	50
11.0	Transmitter Frequency Behaviour	51
12.0	Radiated Emission on Receiving Mode	57
13.0	RF Exposure	60
14.0	FCC ID Label	61
15.0	Photo of Test	62

The report refers only to the sample tested and does not apply to the bulk.

This report is issued in confidence to the client and it will be strictly treated as such by the Shenzhen Timeway Technology Consulting Co.,Ltd. It may not be reproduced rather in its entirety or in part and it may not be used for advertising. The client to whom the report is issued may, however, show or send it, or a certified copy thereof prepared by the Shenzhen Timeway Technology Consulting Co.,Ltd to his customer. Supplier or other persons directly concerned. Shenzhen Timeway Technology Consulting Co.,Ltd will not, without the consent of the client enter into any discussion of correspondence with any third party concerning the contents of the report.

In the event of the improper use of the report, The Shenzhen Timeway Technology Consulting Co.,Ltd reserves the rights to withdraw it and to adopt any other remedies which may be appropriate.



1.0 General Details

1.1 Test Lab Details

Name : SHENZHEN TIMEWAY TECHNOLOGY CONSULTING CO., LTD
Address: 5/F, Block 4, Anhua Industrial Zone., No.8 TaiRan Rd. CheGongMiao, FuTian District, Shenzhen, CHINA.
Telephone: (755) 83448688
Fax: (755) 83442996
Site on File with the Federal Communications Commission – United States
Registration Number: 899988
For 3m & 10 m OATS
Site Listed with Industry Canada of Ottawa, Canada
Registration Number: IC: 5205A-01
For 3m & 10 m OATS

1.2 Applicant Details

Applicant: FUJIAN NAN'AN BAOFENG ELECTRONICS CO., LTD
Address: CHANGFU INDUSTRIAL ZONE, XIAMEI, NNA'AN, QUANZHOU, FUJIAN, CHINA
Telephone: 00886-595-86767889
Fax: 00886-595-86753889

1.3 Description of EUT

Product: Two Way Radio
Manufacturer: FUJIAN NAN'AN BAOFENG ELECTRONICS CO., LTD
Brand Name: BAOFENG
Model Number: UV-5R
Power Source Adapter Model: A-88, Input: 100-240V~0.1A 50-60Hz
Output: DC 10V-0.5A
Type of Modulation FM
Frequency range VHF Band: 136-174MHz; UHF: 400MHz-480MHz
Channel Spacing 12.5 kHz
Frequency Selection By operation
Antenna: Whip antenna with the length of 120mm and the antenna gain is 1.0dBi
Emission Designer 9K10F3E for VHF band and 9K20F3E for UHF band

1.4 Submitted Sample: 2 Samples

1.5 Test Duration

2012-03-12 to 2012-04-25

The report refers only to the sample tested and does not apply to the bulk.

This report is issued in confidence to the client and it will be strictly treated as such by the Shenzhen Timeway Technology Consulting Co., Ltd. It may not be reproduced in its entirety or in part and it may not be used for advertising. The client to whom the report is issued may, however, show or send it, or a certified copy thereof prepared by the Shenzhen Timeway Technology Consulting Co., Ltd to his customer. Supplier or other persons directly concerned. Shenzhen Timeway Technology Consulting Co., Ltd will not, without the consent of the client enter into any discussion of correspondence with any third party concerning the contents of the report.

In the event of the improper use of the report. The Shenzhen Timeway Technology Consulting Co., Ltd reserves the rights to withdraw it and to adopt any other remedies which may be appropriate.

Report No: 1203056

Date: 2012-04-25



Page 5 of 74

1.6 Test Uncertainty

Conducted Emissions Uncertainty =3.6dB

Radiated Emissions Uncertainty =4.7dB

1.7 Test Engineer

The sample tested by _____

Print Name: Terry Tang

The report refers only to the sample tested and does not apply to the bulk.

This report is issued in confidence to the client and it will be strictly treated as such by the Shenzhen Timeway Technology Consulting Co.,Ltd. It may not be reproduced in its entirety or in part and it may not be used for advertising. The client to whom the report is issued may, however, show or send it or a certified copy thereof prepared by the Shenzhen Timeway Technology Consulting Co.,Ltd to his customer. Supplier or other persons directly concerned. Shenzhen Timeway Technology Consulting Co.,Ltd will not, without the consent of the client enter into any discussion of correspondence with any third party concerning the contents of the report.

In the event of the improper use of the report. The Shenzhen Timeway Technology Consulting Co.,Ltd reserves the rights to withdraw it and to adopt any other remedies which may be appropriate.



2.0 Test Equipments					
Instrument Type	Manufacturer	Model	Serial No.	Date of Cal.	Due Date
ESPI Test Receiver	ROHDE&SCHWARZ	ESPI 3	100379	2011-08-26	2012-08-25
TWO Line-V-NETW	ROHDE&SCHWARZ	EZH3-Z5	100294	2011-08-26	2012-08-25
TWO Line-V-NETW	ROHDE&SCHWARZ	EZH3-Z5	100253	2011-08-26	2012-08-25
Ultra Broadband ANT	ROHDE&SCHWARZ	HL562	100157	2011-08-26	2012-08-25
ESDV Test Receiver	ROHDE&SCHWARZ	ESDV	100008	2011-08-26	2012-08-25
Impuls-Begrenzer	ROHDE&SCHWARZ	ESH3-Z2	100281	2011-08-26	2012-08-25
System Controller	CT	SC100	-	2011-08-26	2012-08-25
Oscillator	KENWOOD	AG-203D	3070002	2011-08-26	2012-08-25
5K VA AC Power Source	California Instruments	5001iX	56060	2011-08-26	2012-08-25
Signal Generator	ROHDE&SCHWARZ	SMT03	100029	2011-08-26	2012-08-25
Power Amplifier	AR	150W1000	300999	2011-08-26	2012-08-25
Field probe	Holiday	HI-6005	105152	2011-08-26	2012-08-25
Bilog Antenna	Chase	CBL6111C	2576	2011-08-26	2012-08-25
Loop Antenna	EMCO	6502	00042960	2011-08-26	2012-08-25
ESPI Test Receiver	ROHDE&SCHWARZ	ESI26	838786/013	2011-08-26	2012-08-25
Modulation Analyzer	HP	8901B	3104A03367	2011-08-26	2012-08-25
3m OATS	--	--	N/A	2011-08-26	2012-08-25
Horn Antenna	SCHWARZBECK	BBHA 9170	BBHA9170265	2011-08-26	2012-08-25
Horn Antenna	SCHWARZBECK	BBHA 9120D	9120D-631	2011-08-26	2012-08-25
Power meter	Anritsu	ML2487A	6K00003613	2011-08-26	2012-08-25
Power sensor	Anritsu	MA2491A	32263	2011-08-26	2012-08-25
Bilog Antenna	Schwarebeck	VULB9163	9163/340	2011-08-26	2012-08-25
LISN	AFJ	LS16C	10010947251	2011-08-26	2012-08-25
LISN (Three Phase)	Schwarebeck	NSLK 8126	8126453	2011-08-26	2012-08-25
9*6*6 Anechoic	--	--	N/A	2011-08-26	2012-08-25

The report refers only to the sample tested and does not apply to the bulk.

This report is issued in confidence to the client and it will be strictly treated as such by the Shenzhen Timeway Technology Consulting Co., Ltd. It may not be reproduced rather in its entirety or in part and it may not be used for advertising. The client to whom the report is issued may, however, show or send it, or a certified copy thereof prepared by the Shenzhen Timeway Technology Consulting Co., Ltd. to his customer. Supplier or other persons directly concerned. Shenzhen Timeway Technology Consulting Co., Ltd. will not, without the consent of the client enter into any discussion of correspondence with any third party concerning the contents of the report.

In the event of the improper use of the report, The Shenzhen Timeway Technology Consulting Co., Ltd reserves the rights to withdraw it and to adopt any other remedies which may be appropriate.



3.0 Technical Details

3.1 Summary of test results

The EUT has been tested according to the following specifications:			
	Standard	Test Type	Result
	FCC Part 15.207	Conducted Emission	Compliant
	FCC Part 90.205	Maximum Transmitter Power	Compliant
	FCC Part 90.207	Modulation Characteristic	Compliant
	FCC Part 90.209	Occupied Bandwidth	Compliant
	FCC Part 90.210	Emission Mask	Compliant
	FCC Part 90.213	Frequency Tolerance	Compliant
	FCC Part 90.214	Transient Frequency Behaviour	Compliant

3.2 The tests were performed according to following standards:

- FCC Part 90**
- TIA/EIA 603**
- ANSI C63.4-2009**

4.0 EUT Modification

No modification by Shenzhen Timeway Technology Consulting Co., Ltd

The report refers only to the sample tested and does not apply to the bulk.
This report is issued in confidence to the client and it will be strictly treated as such by the Shenzhen Timeway Technology Consulting Co.,Ltd. It may not be reproduced rather in its entirety or in part and it may not be used for advertising. The client to whom the report is issued may, however, show or send it or a certified copy thereof prepared by the Shenzhen Timeway Technology Consulting Co.,Ltd to his customer. Supplier or other persons directly concerned. Shenzhen Timeway Technology Consulting Co.,Ltd will not, without the consent of the client enter into any discussion of correspondence with any third party concerning the contents of the report.
In the event of the improper use of the report. The Shenzhen Timeway Technology Consulting Co.,Ltd reserves the rights to withdraw it and to adopt any other remedies which may be appropriate.



5. Power Line Conducted Emission Test

5.1 Schematics of the test

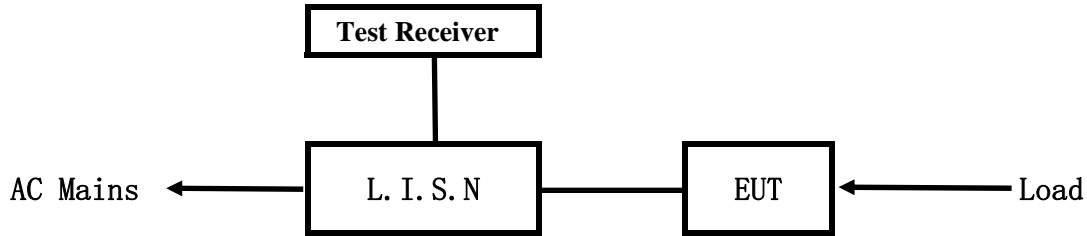

EUT: Equipment Under Test

5.2 Test Method and test Procedure

The EUT was tested according to ANSI C63.4-2009. The Frequency spectrum From 0.15MHz to 30MHz was investigated. The LISN used was 50ohm/50uH as specified by section 5.1 of ANSI C63.4 –2009.

Test Voltage: 120V~, 60Hz

Block diagram of Test setup

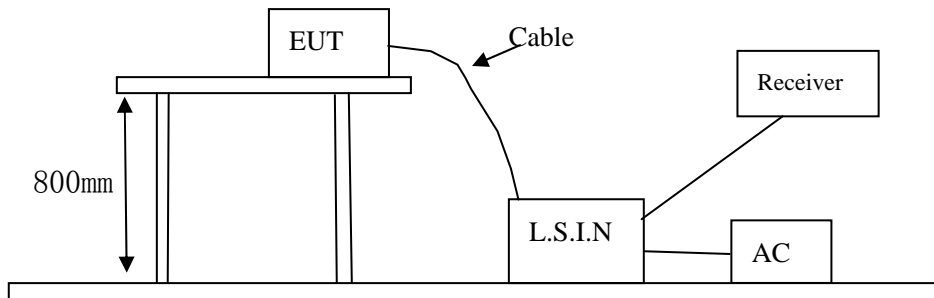

5.3 Configuration of The EUT

The EUT was configured according to ANSI C63.4-2009. All interface ports were connected to the appropriate peripherals. All peripherals and cables are listed below.

One channels are provided to the EUT

A. EUT

Device	Manufacturer	Model	FCC ID
Two Way Radio	FUJIAN NAN'AN BAOFENG ELECTRONICS CO., LTD	UV-5R	ZP5BF-5R

B. Internal Device

Device	Manufacturer	Model	FCC ID/DOC
N/A			

The report refers only to the sample tested and does not apply to the bulk.
This report is issued in confidence to the client and it will be strictly treated as such by the Shenzhen Timeway Technology Consulting Co.,Ltd. It may not be reproduced rather in its entirety or in part and it may not be used for advertising. The client to whom the report is issued may, however, show or send it, or a certified copy thereof prepared by the Shenzhen Timeway Technology Consulting Co.,Ltd to his customer. Supplier or others persons directly concerned. Shenzhen Timeway Technology Consulting Co.,Ltd will not, without the consent of the client enter into any discussion of correspondence with any third party concerning the contents of the report.
In the event of the improper use of the report. The Shenzhen Timeway Technology Consulting Co.,Ltd reserves the rights to withdraw it and to adopt any other remedies which may be appropriate.



C. Peripherals

Device	Manufacturer	Model	FCC ID/DOC	Cable
N/A				

5.4 EUT Operating Condition

Operating condition is according to ANSI C63.4 -2009

A Setup the EUT and simulators as shown on follow

B Enable AF signal and confirm EUT active to normal condition

5.5 Power line conducted Emission Limit according to Paragraph 15.207

Frequency(MHz)	Class A Limits (dB μ V)		Class B Limits (dB μ V)	
	Quasi-peak Level	Average Level	Quasi-peak Level	Average Level
0.15 ~ 0.50	79.0	66.0	66.0~56.0*	56.0~46.0*
0.50 ~ 5.00	73.0	60.0	56.0	46.0
5.00 ~ 30.00	73.0	60.0	60.0	50.0

- Notes:
- *Decreasing linearly with logarithm of frequency.
 - The tighter limit shall apply at the transition frequencies

5.6 Test Results

The frequency spectrum from 0.15MHz to 30MHz was investigated. All reading are quasi-peak values with a resolution bandwidth of 9kHz.

The report refers only to the sample tested and does not apply to the bulk.
 This report is issued in confidence to the client and it will be strictly treated as such by the Shenzhen Timeway Technology Consulting Co.,Ltd. It may not be reproduced rather in its entirety or in part and it may not be used for adverting. The client to whom the report is issued may, however, show or send it . or a certified copy there of prepared by the Shenzhen Timeway Technology Consulting co.,Ltd to his customer. Supplier or others persons directly concerned. Shenzhen Timeway Technology Consulting co.,Ltd will not, without the consent of the client enter into any discussion of correspondence with any third party concerning the contents of the report.
 In the event of the improper use of the report. The Shenzhen Timeway Technology Consulting co.,Ltd reserves the rights to withdraw it and to adopt any other remedies which may be appropriate.



A Conducted Emission on Line Terminal of the power line (150kHz to 30MHz)

EUT set Condition: Charging Mode

Results: Pass

Please refer to following diagram for individual

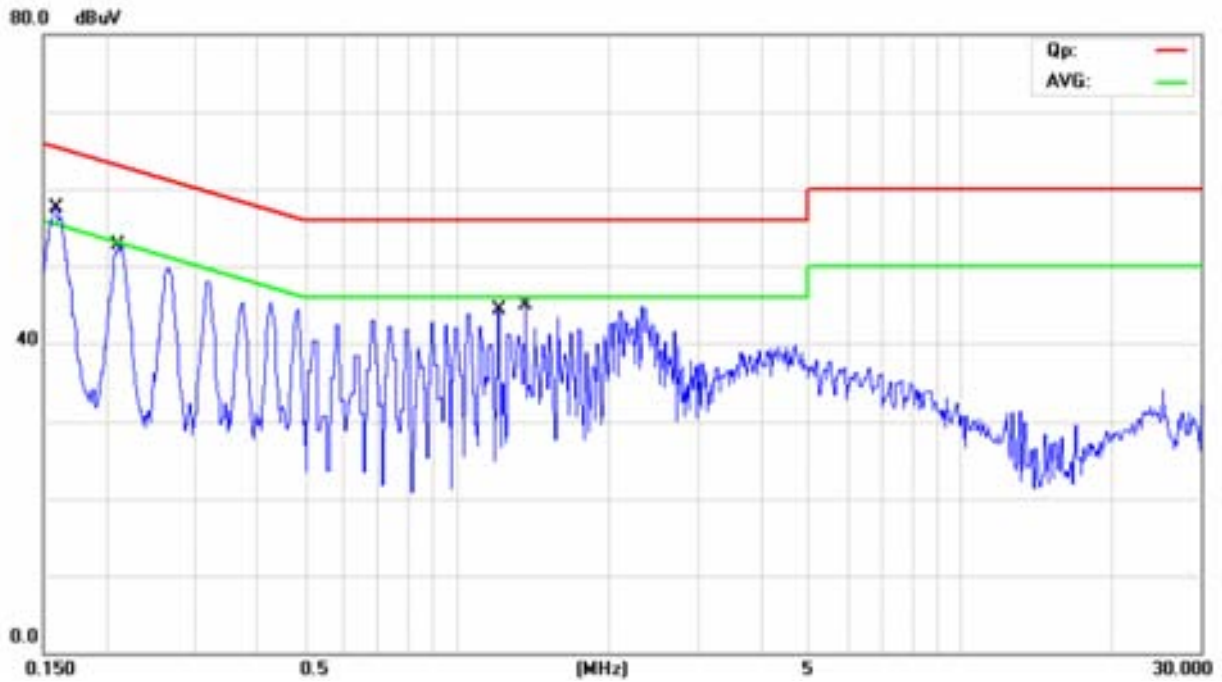

Frequency (MHz)	Reading(dB µ V)				Limit (dB µ V)	
	Line		Neutral		Quasi-peak	Average
	Quasi-peak	Average	Quasi-peak	Average		
0.159	54.61	26.21	--	--	65.50	55.50
1.375	40.05	15.35	--	--	56.00	46.00
0.212	46.47	24.57	--	--	63.11	53.11
1.218	34.19	15.59	--	--	56.00	46.00

The report refers only to the sample tested and does not apply to the bulk.
This report is issued in confidence to the client and it will be strictly treated as such by the Shenzhen Timeway Technology Consulting Co.,Ltd. It may not be reproduced rather in its entirety or in part and it may not be used for advertising. The client to whom the report is issued may, however, show or send it, or a certified copy thereof prepared by the Shenzhen Timeway Technology Consulting Co.,Ltd to his customer. Supplier or other persons directly concerned. Shenzhen Timeway Technology Consulting Co.,Ltd will not, without the consent of the client enter into any discussion of correspondence with any third party concerning the contents of the report.
In the event of the improper use of the report. The Shenzhen Timeway Technology Consulting Co.,Ltd reserves the rights to withdraw it and to adopt any other remedies which may be appropriate.



B Conducted Emission on Neutral Terminal of the power line (150kHz to 30MHz)

EUT set Condition: Charging Mode

Results: Pass

Please refer to following diagram for individual

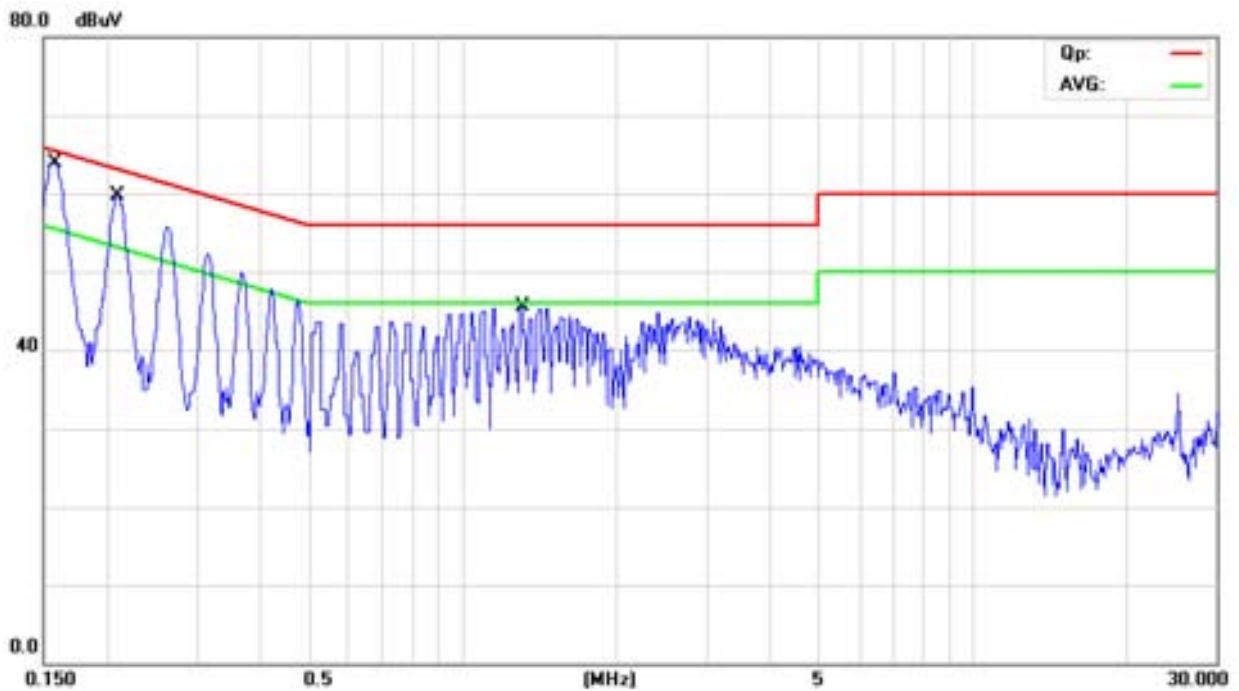

Frequency (MHz)	Reading(dB µ V)				Limit (dB µ V)	
	Live		Neutral		Quasi-peak	Average
	Quasi-peak	Average	Quasi-peak	Average		
0.158	--	--	60.51	32.41	65.57	55.57
0.211	--	--	54.17	16.77	63.15	53.15
1.310	--	--	23.72	5.92	56.00	46.00

The report refers only to the sample tested and does not apply to the bulk.
This report is issued in confidence to the client and it will be strictly treated as such by the Shenzhen Timeway Technology Consulting Co.,Ltd. It may not be reproduced rather in its entirety or in part and it may not be used for advertising. The client to whom the report is issued may, however, show or send it, or a certified copy thereof prepared by the Shenzhen Timeway Technology Consulting Co.,Ltd to his customer. Supplier or other persons directly concerned. Shenzhen Timeway Technology Consulting Co.,Ltd will not, without the consent of the client enter into any discussion of correspondence with any third party concerning the contents of the report.
In the event of the improper use of the report. The Shenzhen Timeway Technology Consulting Co.,Ltd reserves the rights to withdraw it and to adopt any other remedies which may be appropriate.



6. Frequency Tolerance

6.1 Applicable standard

According to FCC Part 90 Section 90.213, In the 421–512 MHz band, mobile stations designed to operate with a 12.5 kHz channel bandwidth must have a frequency stability of 2.5 ppm. In the 150–174 MHz band, mobile stations designed to operate with a 12.5 kHz channel bandwidth must have a frequency stability of 5.0 ppm.

6.2 Measurement Procedure

6.2.1 Frequency stability versus environmental temperature

1. Setup the configuration per figure 1 for frequencies measurement inside an environment chamber, Install new battery in the EUT.
2. Turn on EUT and set SA center frequency to the EUT radiated frequency. Set SA Resolution Bandwidth to 1KHz and Video Resolution Bandwidth to 1KHz and Frequency Span to 50KHz. Record this frequency as reference frequency.
3. Set the temperature of chamber to 60°C. Allow sufficient time (approximately 30 min) for the temperature of the chamber to stabilize. While maintaining a constant temperature inside the chamber, turn the EUT on and measure the EUT operating frequency.
4. Repeat step 2 with a 10°C decreased per stage until the lowest temperature -30°C is measured, record all measured frequencies on each temperature step.

6.2.2 Frequency stability versus input voltage

1. Setup the configuration per figure 1 for frequencies measured at temperature if it is within 15°C to 25°C. Otherwise, an environment chamber set for a temperature of 20°C shall be used. The EUT shall be powered by DC 3.7-4.2 V
2. Set SA center frequency to the EUT radiated frequency. Set SA Resolution Bandwidth to 1 KHz and Video Resolution Bandwidth to 1KHz. Record this frequency as reference frequency.
3. Supply the EUT primary voltage at the operating end point which is specified by manufacturer and record the frequency.

The report refers only to the sample tested and does not apply to the bulk.

This report is issued in confidence to the client and it will be strictly treated as such by the Shenzhen Timeway Technology Consulting Co., Ltd. It may not be reproduced in its entirety or in part and it may not be used for advertising. The client to whom the report is issued may, however, show or send it, or a certified copy thereof prepared by the Shenzhen Timeway Technology Consulting Co., Ltd. to his customer. Supplier or other persons directly concerned. Shenzhen Timeway Technology Consulting Co., Ltd. will not, without the consent of the client enter into any discussion of correspondence with any third party concerning the contents of the report.

In the event of the improper use of the report, The Shenzhen Timeway Technology Consulting Co., Ltd reserves the rights to withdraw it and to adopt any other remedies which may be appropriate.

6.3 TEST SETUP BLOCK DIAGRAM

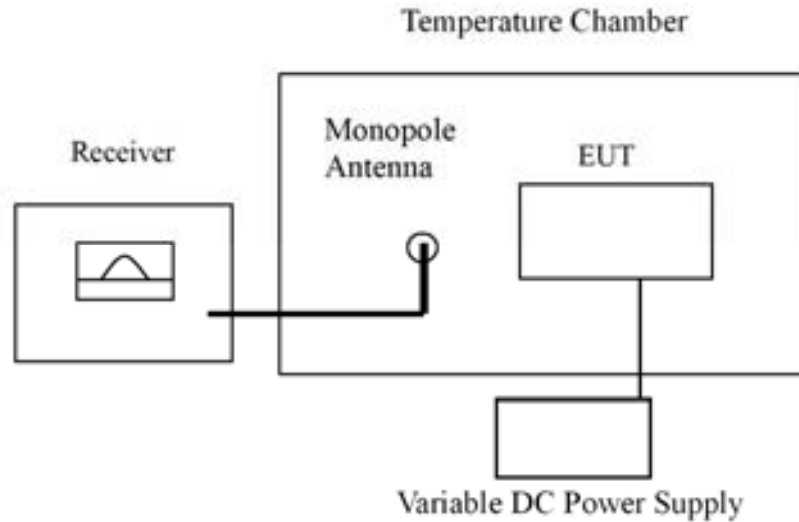

Figure 1

6.5 TEST RESULT

(1) Frequency stability versus input voltage (battery operation end point voltage is 6.5V)

VHF Band:

Channel	Power Supplied (Vdc)	Frequency Measured (MHz)	Frequency Deviation (ppm)	Nominal Frequency	Limit(ppm)
Top channel	6.5V	173.97526	1.49	173.975MHz	5.0
Middle channel	6.5V	155.00038	2.44	156.025MHz	5.0
Bottom channel	6.5V	136.02535	2.57	136.025MHz	5.0

UHF Band:

Channel	Power Supplied (Vdc)	Frequency Measured (MHz)	Frequency Deviation (ppm)	Nominal Frequency	Limit(ppm)
Top channel	6.5V	479.97587	1.81	479.975MHz	2.5
Middle channel	6.5V	440.00073	1.66	440.000MHz	2.5
Bottom channel	6.5V	400.02567	1.67	400.025MHz	2.5

The report refers only to the sample tested and does not apply to the bulk.
This report is issued in confidence to the client and it will be strictly treated as such by the Shenzhen Timeway Technology Consulting Co.,Ltd. It may not be reproduced rather in its entirety or in part and it may not be used for advertising. The client to whom the report is issued may, however, show or send it, or a certified copy thereof prepared by the Shenzhen Timeway Technology Consulting Co.,Ltd to his customer. Supplier or others persons directly concerned. Shenzhen Timeway Technology Consulting Co.,Ltd will not, without the consent of the client enter into any discussion of correspondence with any third party concerning the contents of the report.
In the event of the improper use of the report. The Shenzhen Timeway Technology Consulting Co.,Ltd reserves the rights to withdraw it and to adopt any other remedies which may be appropriate.



(2)Frequency stability versus ambient temperature

Test Results

UHF Band:

Top channel

Environment Temperature(°C)	Power Supplied (Vdc)	Frequency Measured (MHz)	Frequency Deviation (ppm)	Nominal Frequency	Limit(ppm)
50	7.4	479.97528	0.58	479.975MHz	2.5
40	7.4	479.97535	0.72	479.975MHz	2.5
30	7.4	479.97526	0.54	479.975MHz	2.5
20	7.4	479.97531	0.64	479.975MHz	2.5
10	7.4	479.97522	0.45	479.975MHz	2.5
0	7.4	479.97525	0.52	479.975MHz	2.5
-10	7.4	479.97538	0.79	479.975MHz	2.5
-20	7.4	479.97535	0.72	479.975MHz	2.5
-30	7.4	479.97532	0.66	479.975MHz	2.5

Middle channel

Environment Temperature(°C)	Power Supplied (Vdc)	Frequency Measured (MHz)	Frequency Error (ppm)	Nominal Frequency	Limit(ppm)
50	7.4	440.00078	1.77	440.000MHz	2.5
40	7.4	440.00056	1.27	440.000MHz	2.5
30	7.4	440.00067	1.52	440.000MHz	2.5
20	7.4	440.00056	1.27	440.000MHz	2.5
10	7.4	440.00029	0.65	440.000MHz	2.5
0	7.4	440.00072	1.63	440.000MHz	2.5
-10	7.4	440.00047	1.07	440.000MHz	2.5
-20	7.4	440.00062	1.41	440.000MHz	2.5
-30	7.4	440.00058	1.32	440.000MHz	2.5

The report refers only to the sample tested and does not apply to the bulk.

This report is issued in confidence to the client and it will be strictly treated as such by the Shenzhen Timeway Technology Consulting Co.,Ltd. It may not be reproduced rather in its entirety or in part and it may not be used for advertising. The client to whom the report is issued may, however, show or send it or a certified copy thereof prepared by the Shenzhen Timeway Technology Consulting Co.,Ltd to his customer. Supplier or other persons directly concerned. Shenzhen Timeway Technology Consulting Co.,Ltd will not, without the consent of the client enter into any discussion of correspondence with any third party concerning the contents of the report.

In the event of the improper use of the report. The Shenzhen Timeway Technology Consulting Co.,Ltd reserves the rights to withdraw it and to adopt any other remedies which may be appropriate.



Bottom channel

Environment Temperature(°C)	Power Supplied (Vdc)	Frequency Measured (MHz)	Frequency Error (ppm)	Nominal Frequency	Limit(ppm)
50	3.7	400.02517	0.42	400.025MHz	2.5
40	3.7	400.02518	0.44	400.025MHz	2.5
30	3.7	400.02516	0.39	400.025MHz	2.5
20	3.7	400.02522	0.54	400.025MHz	2.5
10	3.7	400.02531	0.77	400.025MHz	2.5
0	3.7	400.02535	0.87	400.025MHz	2.5
-10	3.7	400.02535	0.87	400.025MHz	2.5
-20	3.7	400.02528	0.70	400.025MHz	2.5
-30	3.7	400.02526	0.65	400.025MHz	2.5

VHF Band:

Top channel

Environment Temperature(°C)	Power Supplied (Vdc)	Frequency Measured (MHz)	Frequency Deviation (ppm)	Nominal Frequency	Limit(ppm)
50	7.4	173.97528	1.61	173.975MHz	5.0
40	7.4	173.97535	2.01	173.975MHz	5.0
30	7.4	173.97543	2.47	173.975MHz	5.0
20	7.4	173.97525	1.44	173.975MHz	5.0
10	7.4	173.97526	1.49	173.975MHz	5.0
0	7.4	173.97534	1.95	173.975MHz	5.0
-10	7.4	173.97536	2.07	173.975MHz	5.0
-20	7.4	173.97523	1.32	173.975MHz	5.0
-30	7.4	173.97535	2.01	173.975MHz	5.0

The report refers only to the sample tested and does not apply to the bulk.

This report is issued in confidence to the client and it will be strictly treated as such by the Shenzhen Timeway Technology Consulting Co.,Ltd. It may not be reproduced rather in its entirety or in part and it may not be used for advertising. The client to whom the report is issued may, however, show or send it, or a certified copy thereof prepared by the Shenzhen Timeway Technology Consulting Co.,Ltd to his customer. Supplier or others persons directly concerned. Shenzhen Timeway Technology Consulting Co.,Ltd will not, without the consent of the client enter into any discussion of correspondence with any third party concerning the contents of the report.

In the event of the improper use of the report. The Shenzhen Timeway Technology Consulting Co.,Ltd reserves the rights to withdraw it and to adopt any other remedies which may be appropriate.



Middle channel

Environment Temperature(°C)	Power Supplied (Vdc)	Frequency Measured (MHz)	Frequency Error (ppm)	Nominal Frequency	Limit(ppm)
50	7.4	155.00050MHz	3.22	155.000MHz	5.0
40	7.4	155.00033MHz	2.12	155.000MHz	5.0
30	7.4	155.00043MHz	2.77	155.000MHz	5.0
20	7.4	155.00038MHz	2.45	155.000MHz	5.0
10	7.4	155.00043MHz	2.77	155.000MHz	5.0
0	7.4	155.00055MHz	3.55	155.000MHz	5.0
-10	7.4	155.00029MHz	1.87	155.000MHz	5.0
-20	7.4	155.00029MHz	1.87	155.000MHz	5.0
-30	7.4	155.00052MHz	3.35	155.000MHz	5.0

Bottom channel

Environment Temperature(°C)	Power Supplied (Vdc)	Frequency Measured (MHz)	Frequency Error (ppm)	Nominal Frequency	Limit(ppm)
50	7.4	136.02522	1.62	136.025MHz	5.0
40	7.4	136.02524	1.76	136.025MHz	5.0
30	7.4	136.02533	2.43	136.025MHz	5.0
20	7.4	136.02531	2.28	136.025MHz	5.0
10	7.4	136.02535	2.57	136.025MHz	5.0
0	7.4	136.02527	1.98	136.025MHz	5.0
-10	7.4	136.02528	2.06	136.025MHz	5.0
-20	7.4	136.02523	1.69	136.025MHz	5.0
-30	7.4	136.02526	1.91	136.025MHz	5.0

The report refers only to the sample tested and does not apply to the bulk.
This report is issued in confidence to the client and it will be strictly treated as such by the Shenzhen Timeway Technology Consulting Co., Ltd. It may not be reproduced rather in its entirety or in part and it may not be used for advertising. The client to whom the report is issued may, however, show or send it, or a certified copy thereof prepared by the Shenzhen Timeway Technology Consulting Co., Ltd to his customer. Supplier or others persons directly concerned. Shenzhen Timeway Technology Consulting Co., Ltd will not, without the consent of the client enter into any discussion of correspondence with any third party concerning the contents of the report.
In the event of the improper use of the report. The Shenzhen Timeway Technology Consulting Co., Ltd reserves the rights to withdraw it and to adopt any other remedies which may be appropriate.



7. EMISSION BANDWIDTH and Mask

7.1 PROVISIONS APPLICABLE

Emission Mask D—12.5 kHz channel bandwidth equipment. For transmitters designed to operate with a 12.5 kHz channel bandwidth, any emission must be attenuated below the power (P) of the highest emission contained within the authorized bandwidth as follows:

- (1) On any frequency from the center of the authorized bandwidth f_0 to 5.625 kHz removed from f_0 : Zero dB.
- (2) On any frequency removed from the center of the authorized bandwidth by a displacement frequency (f_d in kHz) of more than 5.625 kHz but no more than 12.5 kHz: At least $7.27(f_d - 2.88 \text{ kHz})$ dB.
- (3) On any frequency removed from the center of the authorized bandwidth by a displacement frequency (f_d in kHz) of more than 12.5 kHz: At least $50 + 10 \log(P)$ dB or 70 dB, whichever is the lesser attenuation.
- (4) The reference level for showing compliance with the emission mask shall be established using a resolution bandwidth sufficiently wide (usually two to three times the channel bandwidth) to capture the true peak emission of the equipment under test. In order to show compliance with the emissions mask up to and including 50 kHz removed from the edge of the authorized bandwidth, adjust the resolution bandwidth to 100 Hz with the measuring instrument in a peak hold mode. A sufficient number of sweeps must be measured to insure that the emission profile is developed. If video filtering is used, its bandwidth must not be less than the instrument resolution bandwidth. For emissions beyond 50 kHz from the edge of the authorized bandwidth, see paragraph (m) of this section. If it can be shown that use of the above instrumentation settings do not accurately represent the true interference potential of the equipment under test, then an alternate procedure may be used provided prior Commission approval is obtained.

7.2 MEASUREMENT PROCEDURE

- 1). The EUT was modulated by 2.5 KHz Sine wave audio signal, The level of the audio signal employed is 16 dB greater than that necessary to produce 50% of rated system deviation. Rated system deviation is 2.5 kHz
- 2). Set SPA Center Frequency = fundamental frequency, RBW=VBW= 300 Hz, Span =50 KHz.
- 3). Set SPA Max hold. Mark peak, -26 dB.

The report refers only to the sample tested and does not apply to the bulk.

This report is issued in confidence to the client and it will be strictly treated as such by the Shenzhen Timeway Technology Consulting Co., Ltd. It may not be reproduced in its entirety or in part and it may not be used for advertising. The client to whom the report is issued may, however, show or send it, or a certified copy thereof prepared by the Shenzhen Timeway Technology Consulting Co., Ltd. to his customer. Supplier or other persons directly concerned. Shenzhen Timeway Technology Consulting Co., Ltd. will not, without the consent of the client enter into any discussion of correspondence with any third party concerning the contents of the report.

In the event of the improper use of the report, The Shenzhen Timeway Technology Consulting Co., Ltd reserves the rights to withdraw it and to adopt any other remedies which may be appropriate.



7.3 Test Setup Block Diagram

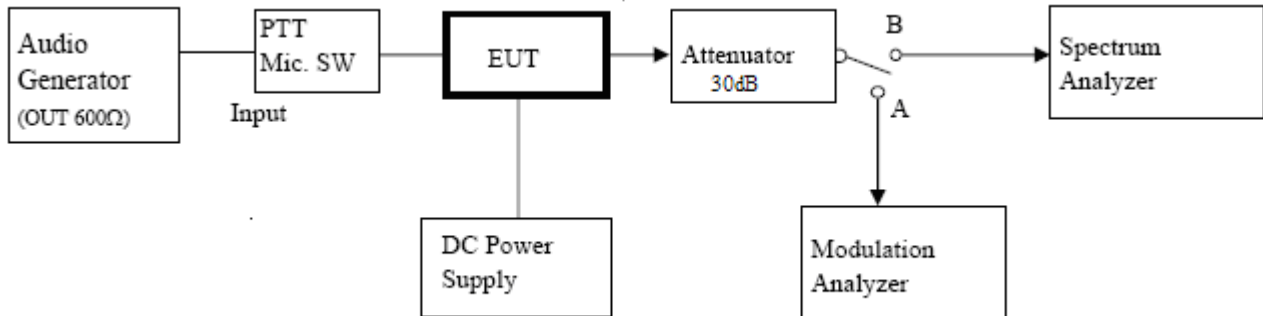

7.4 Measurement Result:

Bandwidth				
Operating Frequency	26dB Bandwidth	99% Bandwidth	Limits	Result
136.025MHz (Bottom)	9.1kHz	6.9kHz	11.25 KHz	Pass
400.025MHz (Bottom)	9.1kHz	6.9kHz	11.25 KHz	Pass

Bandwidth				
Operating Frequency	26dB Bandwidth	99% Bandwidth	Limits	Result
155.000MHz (Middle)	9.0kHz	6.8kHz	11.25 KHz	Pass
440.000MHz (Middle)	9.1kHz	6.9kHz	11.25 KHz	Pass

Bandwidth				
Operating Frequency	26dB Bandwidth	99% Bandwidth	Limits	Result
173.975MHz (Top)	9.1kHz	6.8kHz	11.25 KHz	Pass
479.975MHz (Top)	9.2kHz	7.0kHz	11.25 KHz	Pass

Note: A 30dB attenuator was used during the tests

The report refers only to the sample tested and does not apply to the bulk.
This report is issued in confidence to the client and it will be strictly treated as such by the Shenzhen Timeway Technology Consulting Co., Ltd. It may not be reproduced rather in its entirety or in part and it may not be used for advertising. The client to whom the report is issued may, however, show or send it, or a certified copy thereof prepared by the Shenzhen Timeway Technology Consulting Co., Ltd to his customer. Supplier or others persons directly concerned. Shenzhen Timeway Technology Consulting Co., Ltd will not, without the consent of the client enter into any discussion of correspondence with any third party concerning the contents of the report.
In the event of the improper use of the report. The Shenzhen Timeway Technology Consulting Co., Ltd reserves the rights to withdraw it and to adopt any other remedies which may be appropriate.



7.5 Test Plots:

VHF Band- Bottom Channel

26dB Bandwidth

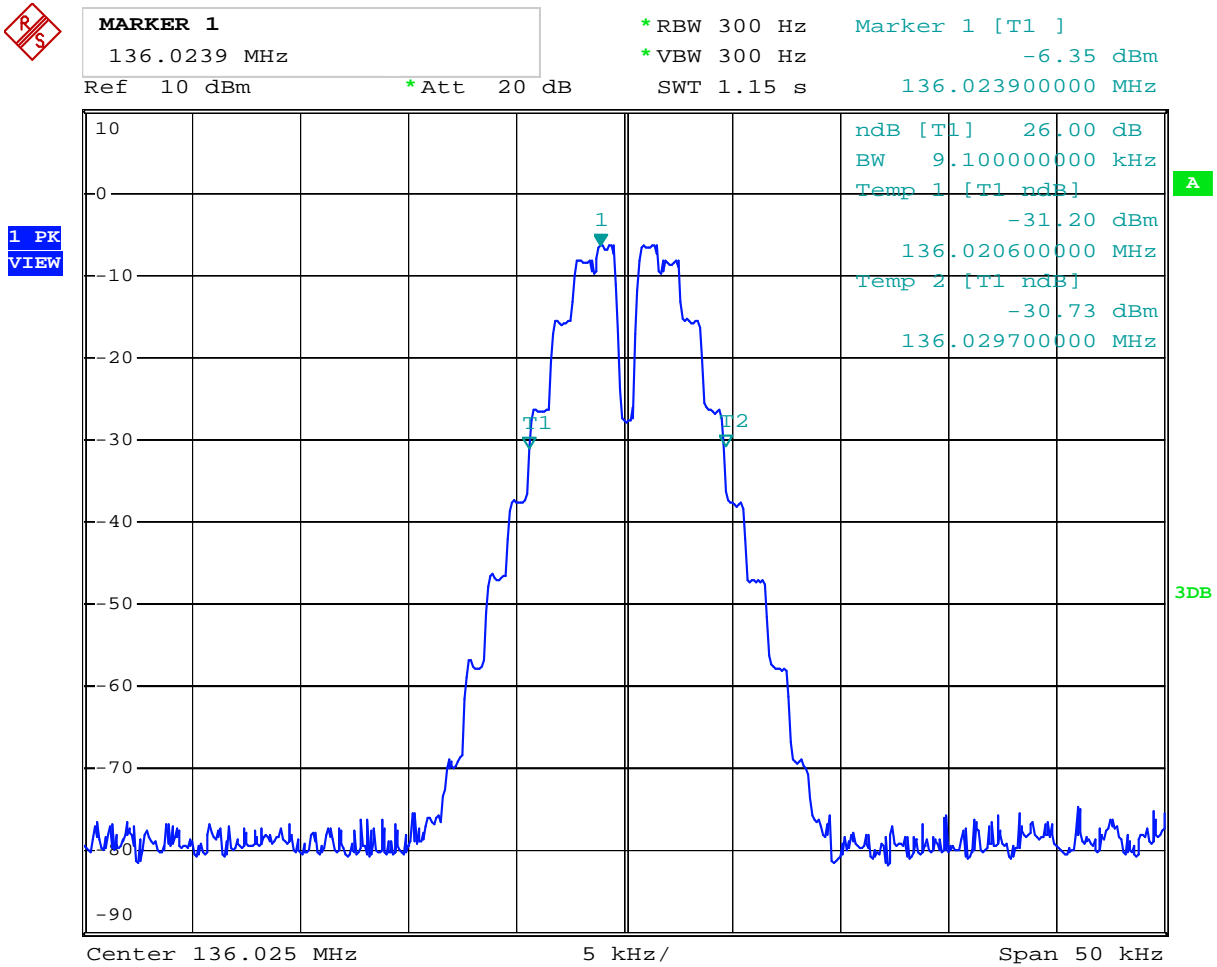

Date: 25.APR.2012 10:24:38

The report refers only to the sample tested and does not apply to the bulk.
 This report is issued in confidence to the client and it will be strictly treated as such by the Shenzhen Timeway Technology Consulting Co.,Ltd. It may not be reproduced rather in its entirety or in part and it may not be used for adverting. The client to whom the report is issued may, however, show or send it . or a certified copy there of prepared by the Shenzhen Timeway Technology Consulting co.,Ltd to his customer. Supplier or others persons directly concerned. Shenzhen Timeway Technology Consulting co.,Ltd will not, without the consent of the client enter into any discussion of correspondence with any third party concerning the contents of the report.
 In the event of the improper use of the report. The Shenzhen Timeway Technology Consulting co.,Ltd reserves the rights to withdraw it and to adopt any other remedies which may be appropriate.



VHF Band- Bottom Channel

99% Bandwidth

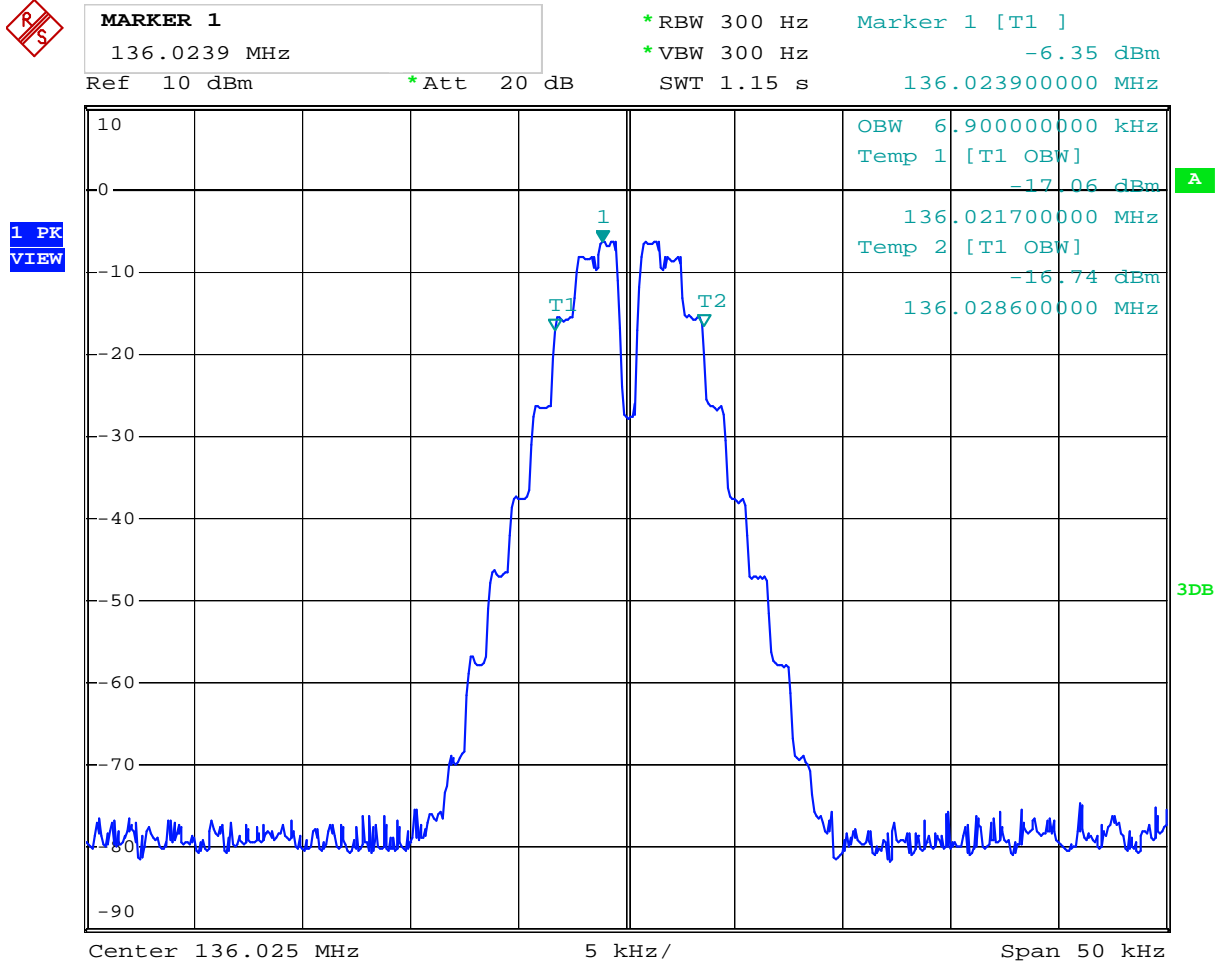

Date: 25.APR.2012 10:23:56

The report refers only to the sample tested and does not apply to the bulk.
 This report is issued in confidence to the client and it will be strictly treated as such by the Shenzhen Timeway Technology Consulting Co.,Ltd. It may not be reproduced in its entirety or in part and it may not be used for advertising. The client to whom the report is issued may, however, show or send it or a certified copy thereof prepared by the Shenzhen Timeway Technology Consulting Co.,Ltd to his customer. Supplier or other persons directly concerned. Shenzhen Timeway Technology Consulting Co.,Ltd will not, without the consent of the client enter into any discussion of correspondence with any third party concerning the contents of the report.
 In the event of the improper use of the report. The Shenzhen Timeway Technology Consulting Co.,Ltd reserves the rights to withdraw it and to adopt any other remedies which may be appropriate.



VHF Band- Bottom Channel

Emission Mask

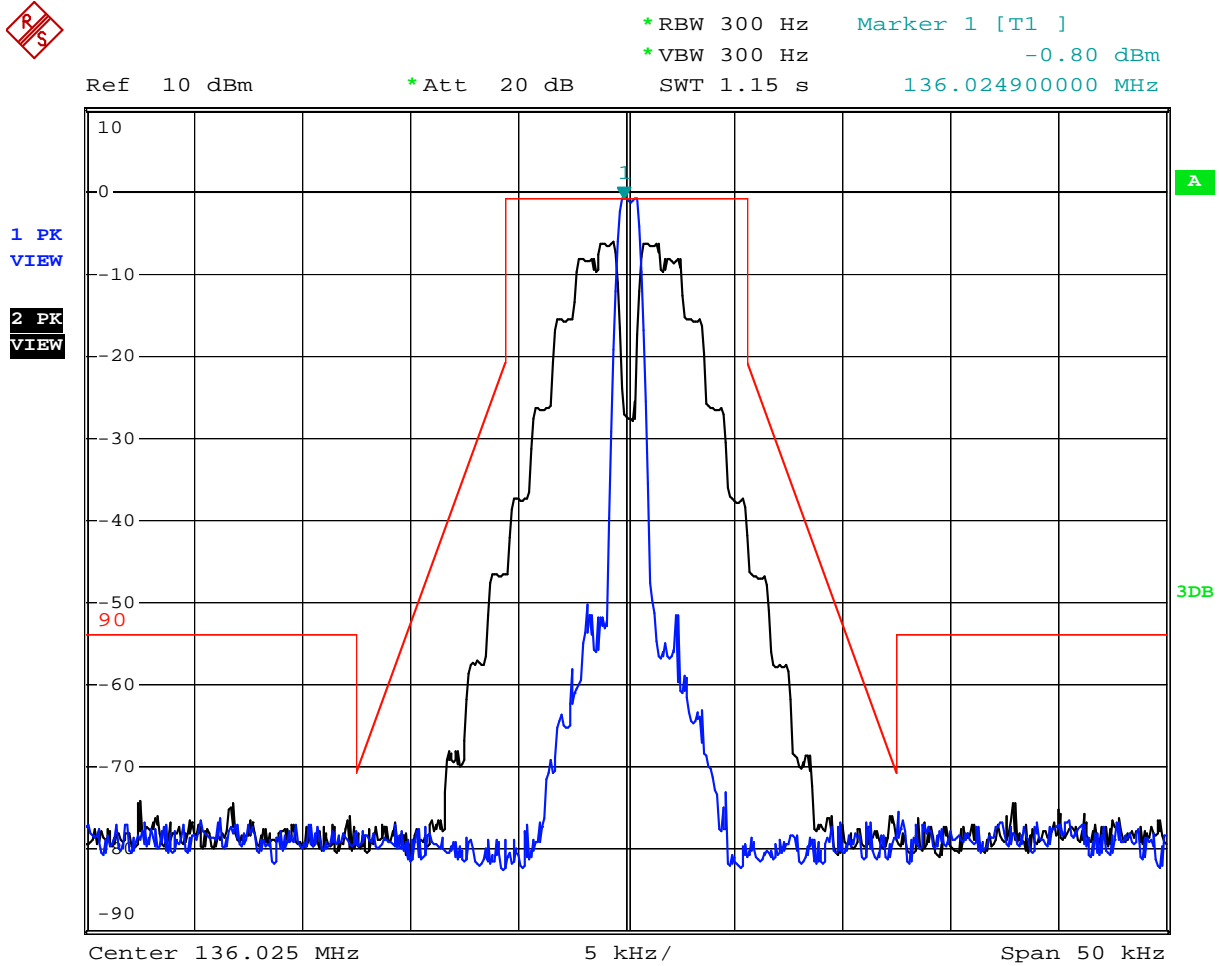

Date: 25.APR.2012 10:21:30

The report refers only to the sample tested and does not apply to the bulk.
This report is issued in confidence to the client and it will be strictly treated as such by the Shenzhen Timeway Technology Consulting Co.,Ltd. It may not be reproduced in its entirety or in part and it may not be used for advertising. The client to whom the report is issued may, however, show or send it or a certified copy thereof prepared by the Shenzhen Timeway Technology Consulting Co.,Ltd to his customer. Supplier or other persons directly concerned. Shenzhen Timeway Technology Consulting Co.,Ltd will not, without the consent of the client enter into any discussion of correspondence with any third party concerning the contents of the report.
In the event of the improper use of the report. The Shenzhen Timeway Technology Consulting Co.,Ltd reserves the rights to withdraw it and to adopt any other remedies which may be appropriate.



UHF Band- Bottom Channel

26dB Bandwidth



ndB DOWN VALUE
 26 dB
 Ref 10 dBm *Att 20 dB

*RBW 300 Hz Marker 1 [T1]
 *VBW 300 Hz -7.07 dBm
 SWT 1.15 s 400.024400000 MHz

1 PK
 VIEW

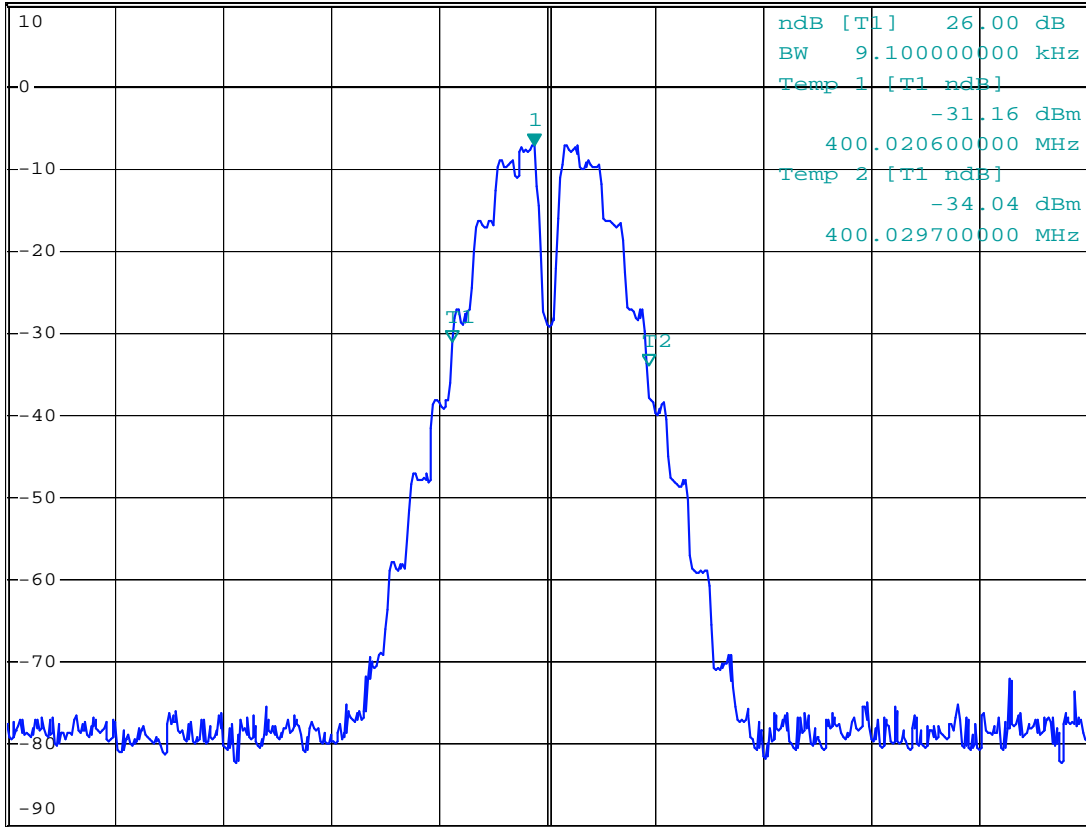

Center 400.025 MHz 5 kHz/ Span 50 kHz

Date: 25.APR.2012 10:37:23

The report refers only to the sample tested and does not apply to the bulk.
 This report is issued in confidence to the client and it will be strictly treated as such by the Shenzhen Timeway Technology Consulting Co.,Ltd. It may not be reproduced rather in its entirety or in part and it may not be used for advertising. The client to whom the report is issued may, however, show or send it . or a certified copy there of prepared by the Shenzhen Timeway Technology Consulting co.,Ltd to his customer. Supplier or others persons directly concerned. Shenzhen Timeway Technology Consulting co.,Ltd will not, without the consent of the client enter into any discussion of correspondence with any third party concerning the contents of the report.
 In the event of the improper use of the report. The Shenzhen Timeway Technology Consulting co.,Ltd reserves the rights to withdraw it and to adopt any other remedies which may be appropriate.



UHF Band- Bottom Channel

99% Bandwidth



*RBW 300 Hz Marker 1 [T1]
 *VBW 300 Hz -7.07 dBm
 SWT 1.15 s 400.024400000 MHz

Ref 10 dBm

*Att 20 dB

1 PK
 VIEW

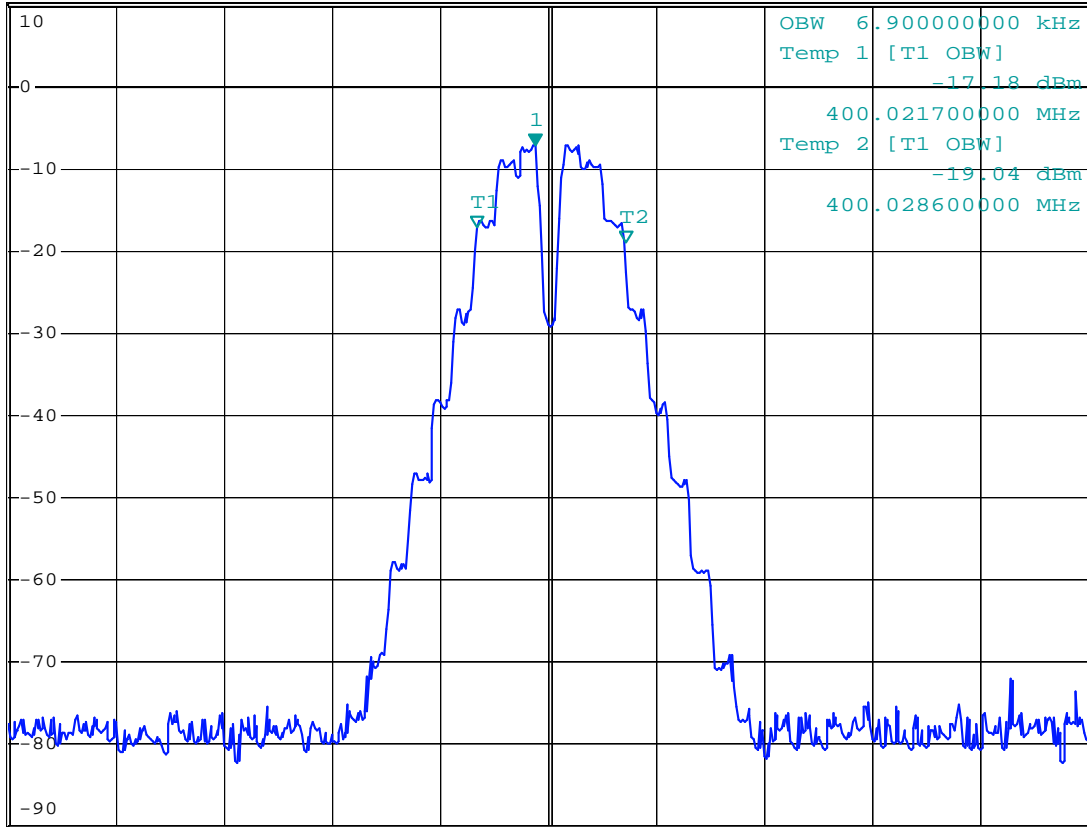

Center 400.025 MHz

5 kHz/

Span 50 kHz

Date: 25.APR.2012 10:37:03

The report refers only to the sample tested and does not apply to the bulk.
 This report is issued in confidence to the client and it will be strictly treated as such by the Shenzhen Timeway Technology Consulting Co.,Ltd. It may not be reproduced in its entirety or in part and it may not be used for advertising. The client to whom the report is issued may, however, show or send it or a certified copy thereof prepared by the Shenzhen Timeway Technology Consulting Co.,Ltd to his customer. Supplier or other persons directly concerned. Shenzhen Timeway Technology Consulting Co.,Ltd will not, without the consent of the client enter into any discussion of correspondence with any third party concerning the contents of the report.
 In the event of the improper use of the report. The Shenzhen Timeway Technology Consulting Co.,Ltd reserves the rights to withdraw it and to adopt any other remedies which may be appropriate.



UHF Band- Bottom Channel

Emission Mask

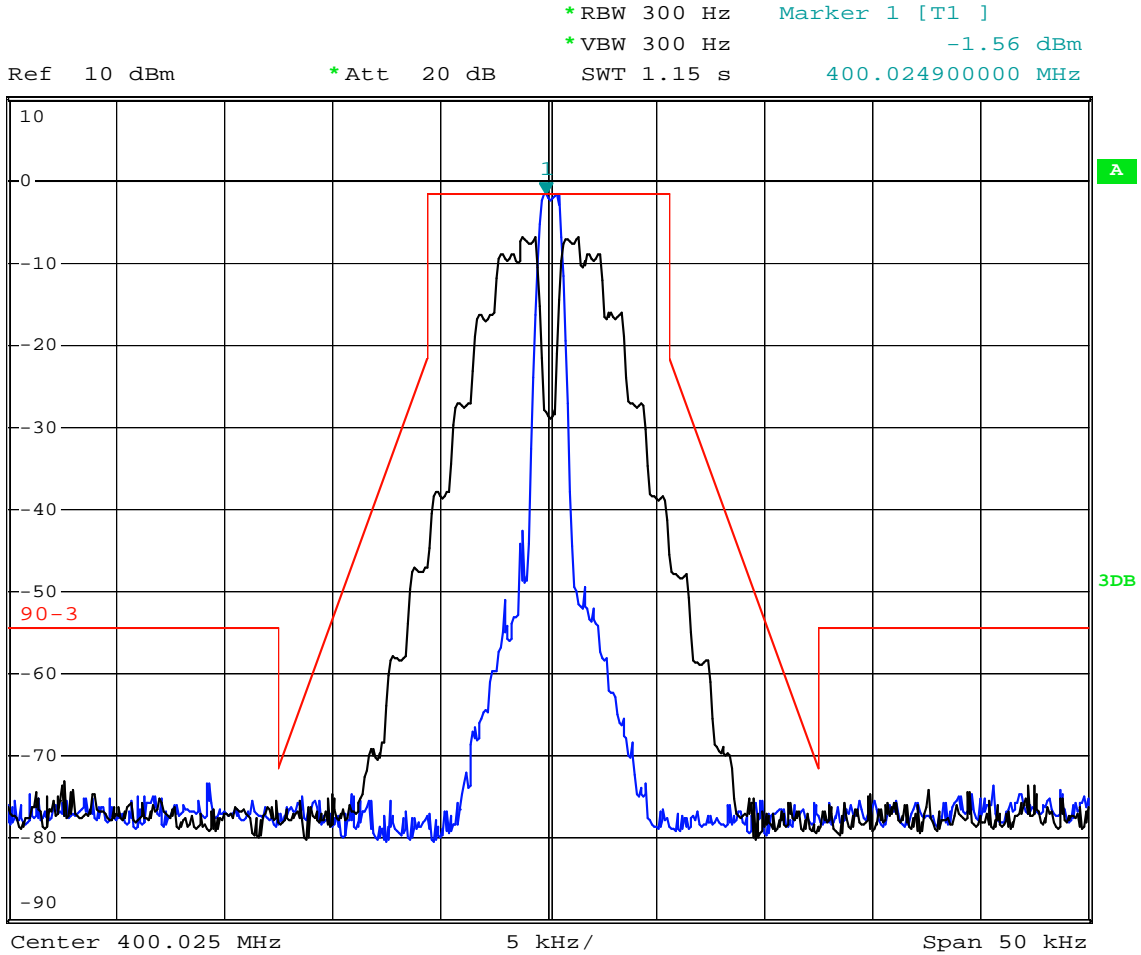

Date: 25.APR.2012 10:36:01

The report refers only to the sample tested and does not apply to the bulk.
This report is issued in confidence to the client and it will be strictly treated as such by the Shenzhen Timeway Technology Consulting Co.,Ltd. It may not be reproduced in its entirety or in part and it may not be used for advertising. The client to whom the report is issued may, however, show or send it, or a certified copy thereof prepared by the Shenzhen Timeway Technology Consulting Co.,Ltd to his customer. Supplier or other persons directly concerned. Shenzhen Timeway Technology Consulting Co.,Ltd will not, without the consent of the client enter into any discussion of correspondence with any third party concerning the contents of the report.
In the event of the improper use of the report. The Shenzhen Timeway Technology Consulting Co.,Ltd reserves the rights to withdraw it and to adopt any other remedies which may be appropriate.



VHF Band-Middle Channel

26dB Bandwidth



ndB DOWN VALUE
 26 dB
 Ref 10 dBm *Att 20 dB

*RBW 300 Hz Marker 1 [T1]
 *VBW 300 Hz -7.20 dBm
 SWT 1.15 s 155.00090000 MHz

1 PK
 VIEW

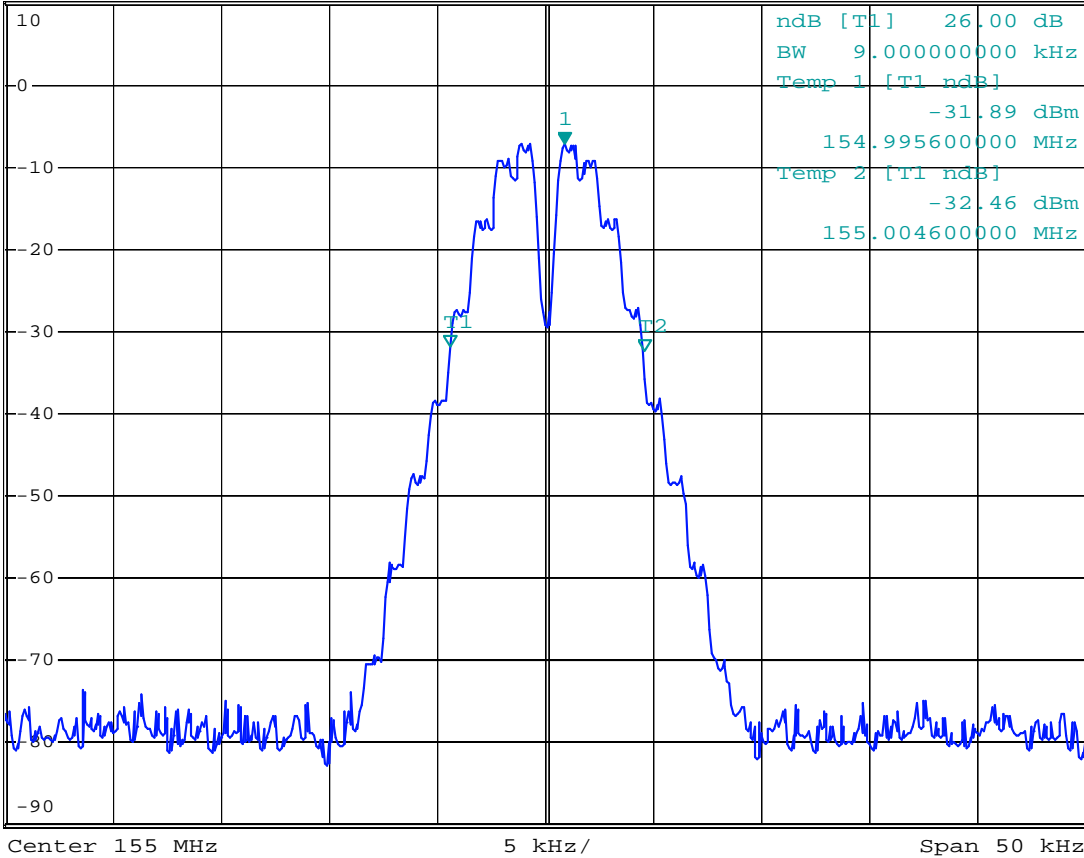

Date: 25.APR.2012 10:49:18

The report refers only to the sample tested and does not apply to the bulk.
 This report is issued in confidence to the client and it will be strictly treated as such by the Shenzhen Timeway Technology Consulting Co.,Ltd. It may not be reproduced rather in its entirety or in part and it may not be used for adverting. The client to whom the report is issued may, however, show or send it . or a certified copy there of prepared by the Shenzhen Timeway Technology Consulting co.,Ltd to his customer. Supplier or others persons directly concerned. Shenzhen Timeway Technology Consulting co.,Ltd will not, without the consent of the client enter into any discussion of correspondence with any third party concerning the contents of the report.
 In the event of the improper use of the report. The Shenzhen Timeway Technology Consulting co.,Ltd reserves the rights to withdraw it and to adopt any other remedies which may be appropriate.



VHF Band-Middle Channel

99% Bandwidth

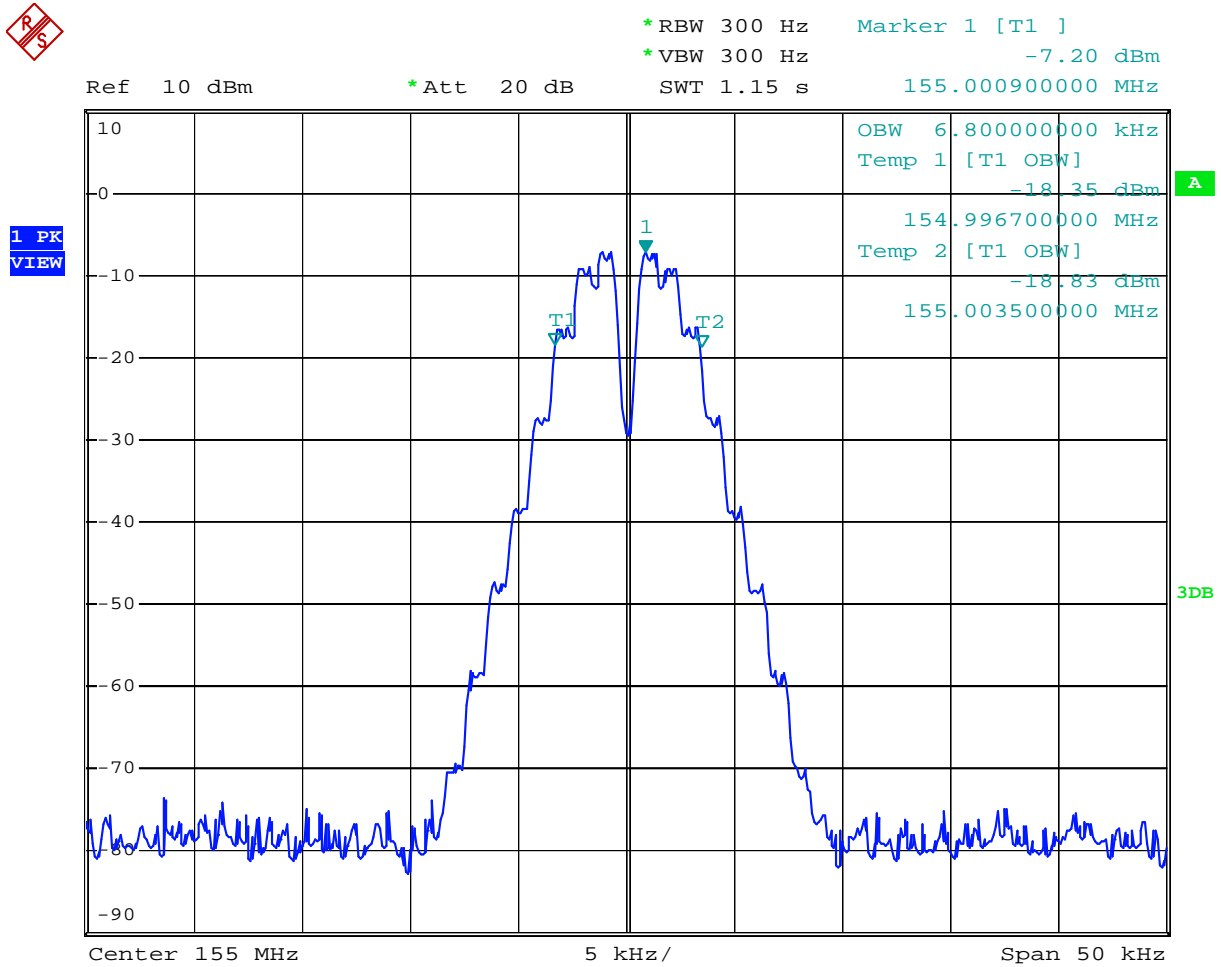

Date: 25.APR.2012 10:49:04

The report refers only to the sample tested and does not apply to the bulk.
 This report is issued in confidence to the client and it will be strictly treated as such by the Shenzhen Timeway Technology Consulting Co.,Ltd. It may not be reproduced rather in its entirety or in part and it may not be used for advertng. The client to whom the report is issued may, however, show or send it . or a certified copy there of prepared by the Shenzhen Timeway Technology Consulting co.,Ltd to his customer. Supplier or others persons directly concerned. Shenzhen Timeway Technology Consulting co.,Ltd will not, without the consent of the client enter into any discussion of correspondence with any third party concerning the contents of the report.
 In the event of the improper use of the report. The Shenzhen Timeway Technology Consulting co.,Ltd reserves the rights to withdraw it and to adopt any other remedies which may be appropriate.



VHF Band-Middle Channel

Emission Mask



*RBW 300 Hz Marker 1 [T1]
*VBW 300 Hz -1.89 dBm
SWT 1.15 s 155.000300000 MHz

Ref 10 dBm *Att 20 dB

1 PK
VIEW

2 PK
MAXH

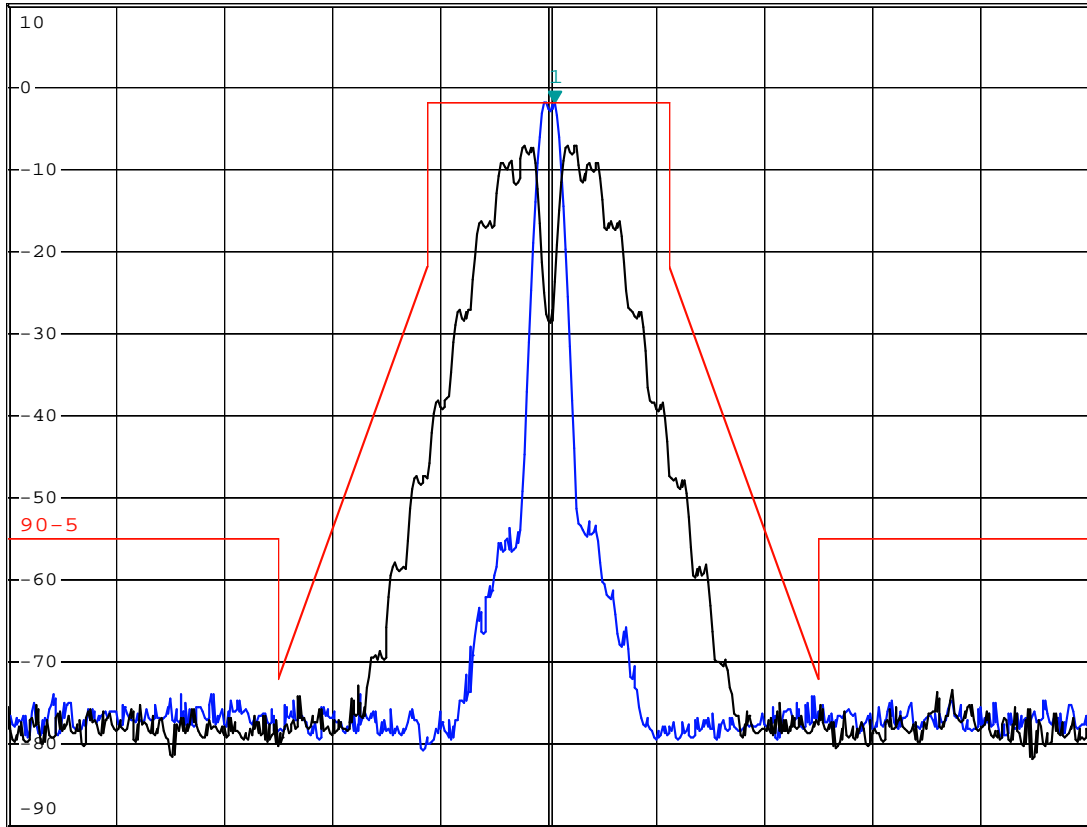

Center 155 MHz 5 kHz/ Span 50 kHz

Date: 25.APR.2012 10:48:15

The report refers only to the sample tested and does not apply to the bulk.
This report is issued in confidence to the client and it will be strictly treated as such by the Shenzhen Timeway Technology Consulting Co.,Ltd. It may not be reproduced rather in its entirety or in part and it may not be used for adverting. The client to whom the report is issued may, however, show or send it . or a certified copy there of prepared by the Shenzhen Timeway Technology Consulting co.,Ltd to his customer. Supplier or others persons directly concerned. Shenzhen Timeway Technology Consulting co.,Ltd will not, without the consent of the client enter into any discussion of correspondence with any third party concerning the contents of the report.
In the event of the improper use of the report. The Shenzhen Timeway Technology Consulting co.,Ltd reserves the rights to withdraw it and to adopt any other remedies which may be appropriate.



UHF Band-Middle Channel

26dB Bandwidth



ndB DOWN VALUE
 26 dB
 Ref 10 dBm *Att 20 dB

*RBW 300 Hz Marker 1 [T1]
 *VBW 300 Hz -5.29 dBm
 SWT 1.15 s 439.998900000 MHz

1 PK
 VIEW

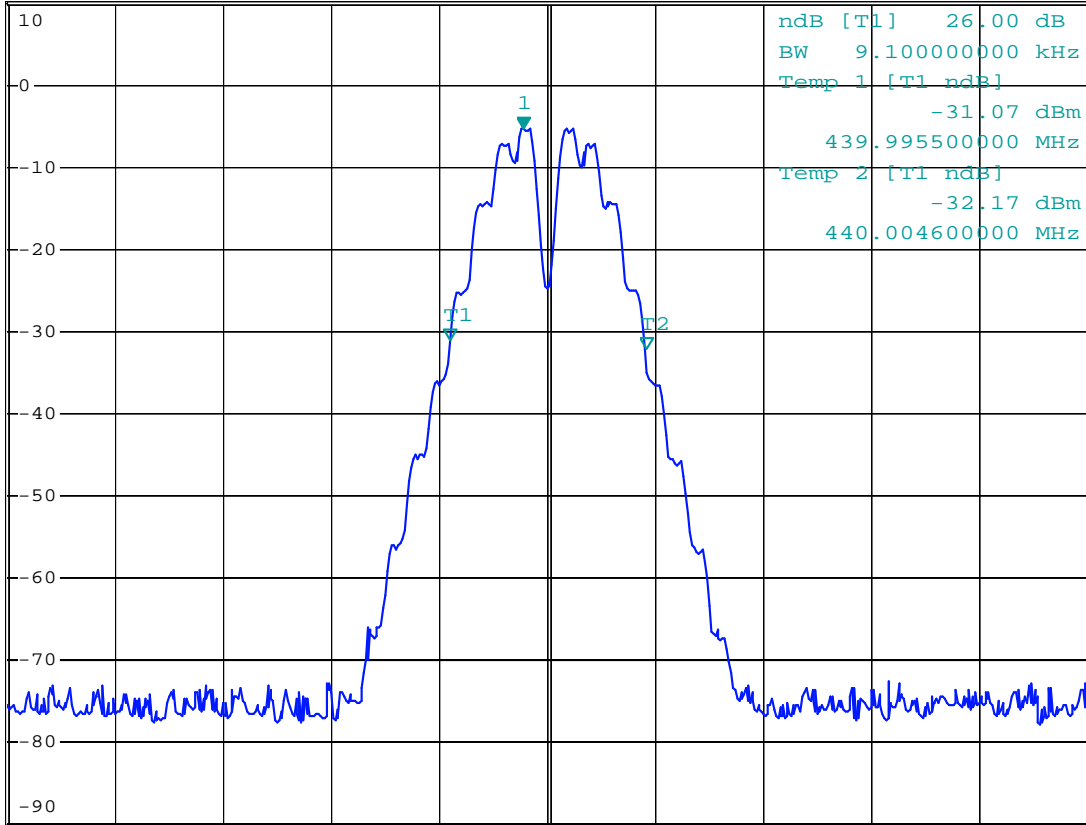

A

3DB

Center 440 MHz 5 kHz/ Span 50 kHz

Date: 25.APR.2012 10:54:51

The report refers only to the sample tested and does not apply to the bulk.
 This report is issued in confidence to the client and it will be strictly treated as such by the Shenzhen Timeway Technology Consulting Co.,Ltd. It may not be reproduced rather in its entirety or in part and it may not be used for advertising. The client to whom the report is issued may, however, show or send it or a certified copy thereof prepared by the Shenzhen Timeway Technology Consulting Co.,Ltd to his customer. Supplier or others persons directly concerned. Shenzhen Timeway Technology Consulting Co.,Ltd will not, without the consent of the client enter into any discussion of correspondence with any third party concerning the contents of the report.
 In the event of the improper use of the report. The Shenzhen Timeway Technology Consulting Co.,Ltd reserves the rights to withdraw it and to adopt any other remedies which may be appropriate.



UHF Band-Middle Channel

99% Bandwidth



*RBW 300 Hz Marker 1 [T1] -5.29 dBm
 *VBW 300 Hz
 Ref 10 dBm *Att 20 dB SWT 1.15 s 439.998900000 MHz

1 PK
 VIEW

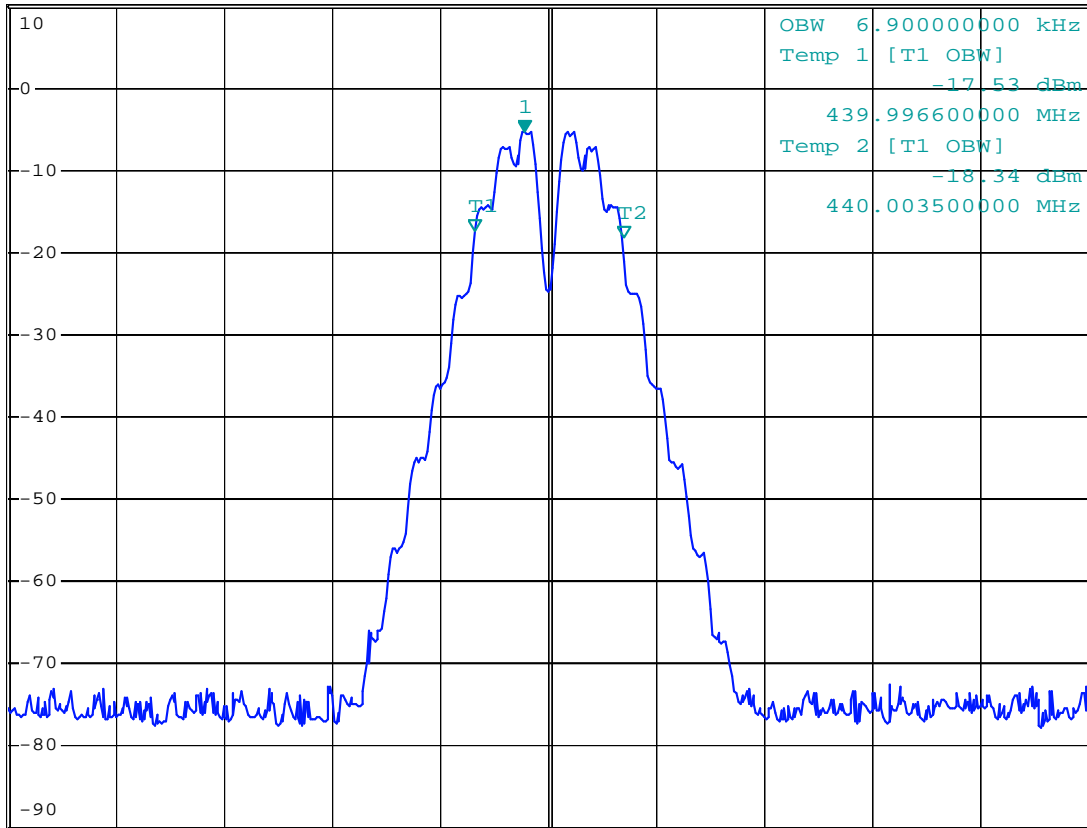

Center 440 MHz 5 kHz/ Span 50 kHz

Date: 25.APR.2012 10:54:33

The report refers only to the sample tested and does not apply to the bulk.
 This report is issued in confidence to the client and it will be strictly treated as such by the Shenzhen Timeway Technology Consulting Co.,Ltd. It may not be reproduced rather in its entirety or in part and it may not be used for advertng. The client to whom the report is issued may, however, show or send it . or a certified copy there of prepared by the Shenzhen Timeway Technology Consulting co.,Ltd to his customer. Supplier or others persons directly concerned. Shenzhen Timeway Technology Consulting co.,Ltd will not, without the consent of the client enter into any discussion of correspondence with any third party concerning the contents of the report.
 In the event of the improper use of the report. The Shenzhen Timeway Technology Consulting co.,Ltd reserves the rights to withdraw it and to adopt any other remedies which may be appropriate.



UHF Band-Middle Channel

Emission Mask



MARKER 1
 439.9999 MHz
 Ref 10 dBm *Att 20 dB

*RBW 300 Hz Marker 1 [T1]
 *VBW 300 Hz -0.08 dBm
 SWT 1.15 s 439.999900000 MHz

1 PK
 VIEW

2 PK
 VIEW

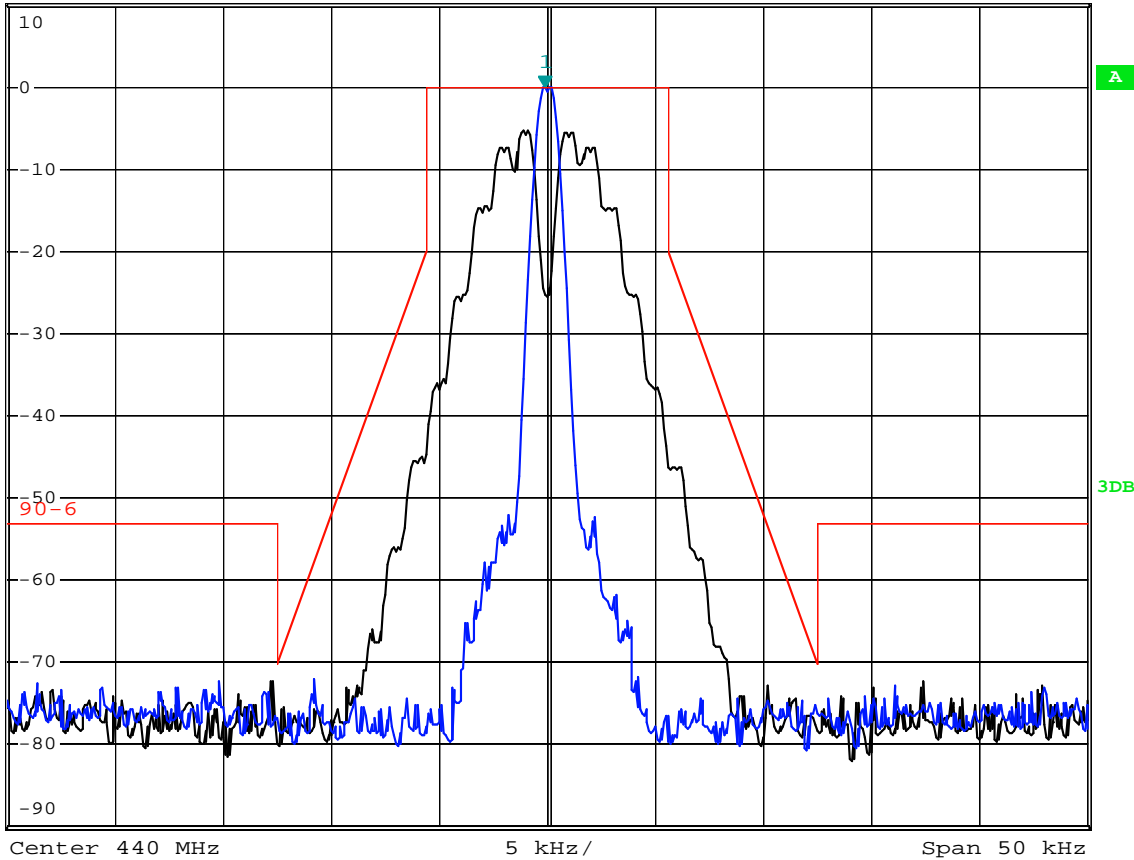

Date: 25.APR.2012 10:52:40

The report refers only to the sample tested and does not apply to the bulk.
 This report is issued in confidence to the client and it will be strictly treated as such by the Shenzhen Timeway Technology Consulting Co.,Ltd. It may not be reproduced rather in its entirety or in part and it may not be used for advertising. The client to whom the report is issued may, however, show or send it or a certified copy there of prepared by the Shenzhen Timeway Technology Consulting co.,Ltd to his customer. Supplier or others persons directly concerned. Shenzhen Timeway Technology Consulting co.,Ltd will not, without the consent of the client enter into any discussion of correspondence with any third party concerning the contents of the report.
 In the event of the improper use of the report. The Shenzhen Timeway Technology Consulting co.,Ltd reserves the rights to withdraw it and to adopt any other remedies which may be appropriate.



VHF Band-Top Channel

26dB Bandwidth



MARKER 1
 173.976 MHz
 Ref 10 dBm *Att 20 dB

*RBW 300 Hz Marker 1 [T1]
 *VBW 300 Hz -6.77 dBm
 SWT 1.15 s 173.97600000 MHz

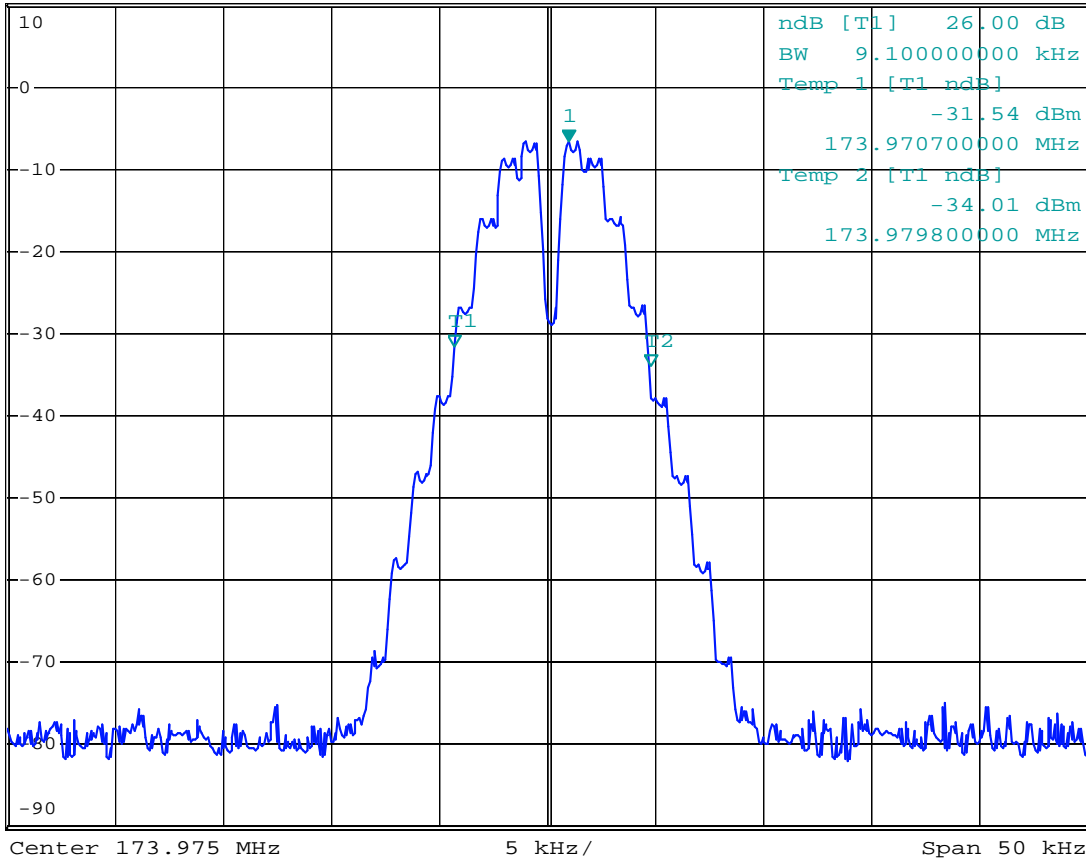

Date: 25.APR.2012 10:30:51

The report refers only to the sample tested and does not apply to the bulk.
 This report is issued in confidence to the client and it will be strictly treated as such by the Shenzhen Timeway Technology Consulting Co.,Ltd. It may not be reproduced in its entirety or in part and it may not be used for advertising. The client to whom the report is issued may, however, show or send it, or a certified copy thereof prepared by the Shenzhen Timeway Technology Consulting Co.,Ltd to his customer. Supplier or other persons directly concerned. Shenzhen Timeway Technology Consulting Co.,Ltd will not, without the consent of the client enter into any discussion of correspondence with any third party concerning the contents of the report.
 In the event of the improper use of the report. The Shenzhen Timeway Technology Consulting Co.,Ltd reserves the rights to withdraw it and to adopt any other remedies which may be appropriate.



VHF Band-Top Channel

99% Bandwidth

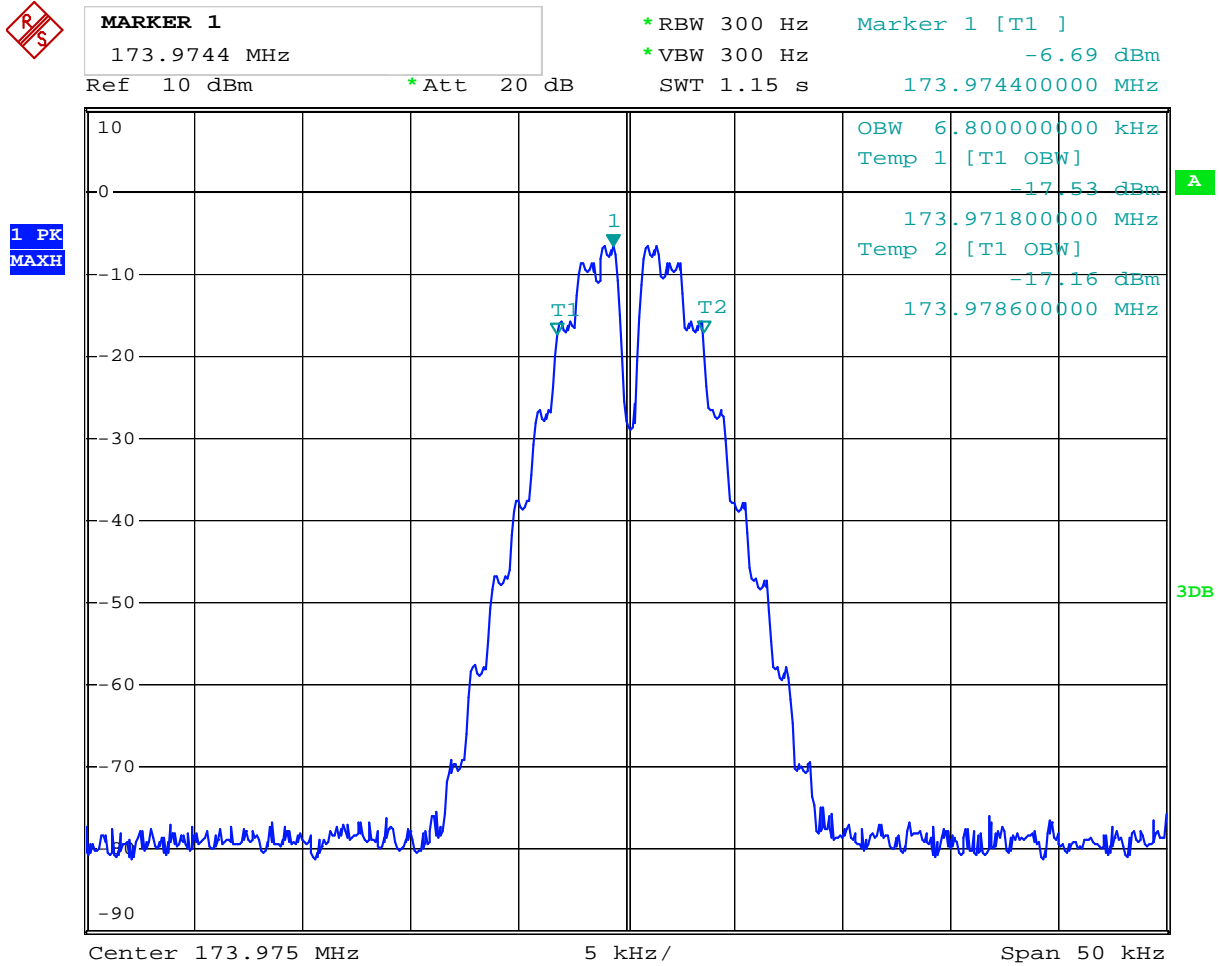

Date: 25.APR.2012 10:31:34

The report refers only to the sample tested and does not apply to the bulk.
This report is issued in confidence to the client and it will be strictly treated as such by the Shenzhen Timeway Technology Consulting Co.,Ltd. It may not be reproduced rather in its entirety or in part and it may not be used for adverting. The client to whom the report is issued may, however, show or send it . or a certified copy there of prepared by the Shenzhen Timeway Technology Consulting co.,Ltd to his customer. Supplier or others persons directly concerned. Shenzhen Timeway Technology Consulting co.,Ltd will not, without the consent of the client enter into any discussion of correspondence with any third party concerning the contents of the report.
In the event of the improper use of the report. The Shenzhen Timeway Technology Consulting co.,Ltd reserves the rights to withdraw it and to adopt any other remedies which may be appropriate.



VHF Band-Top Channel

Emission Mask

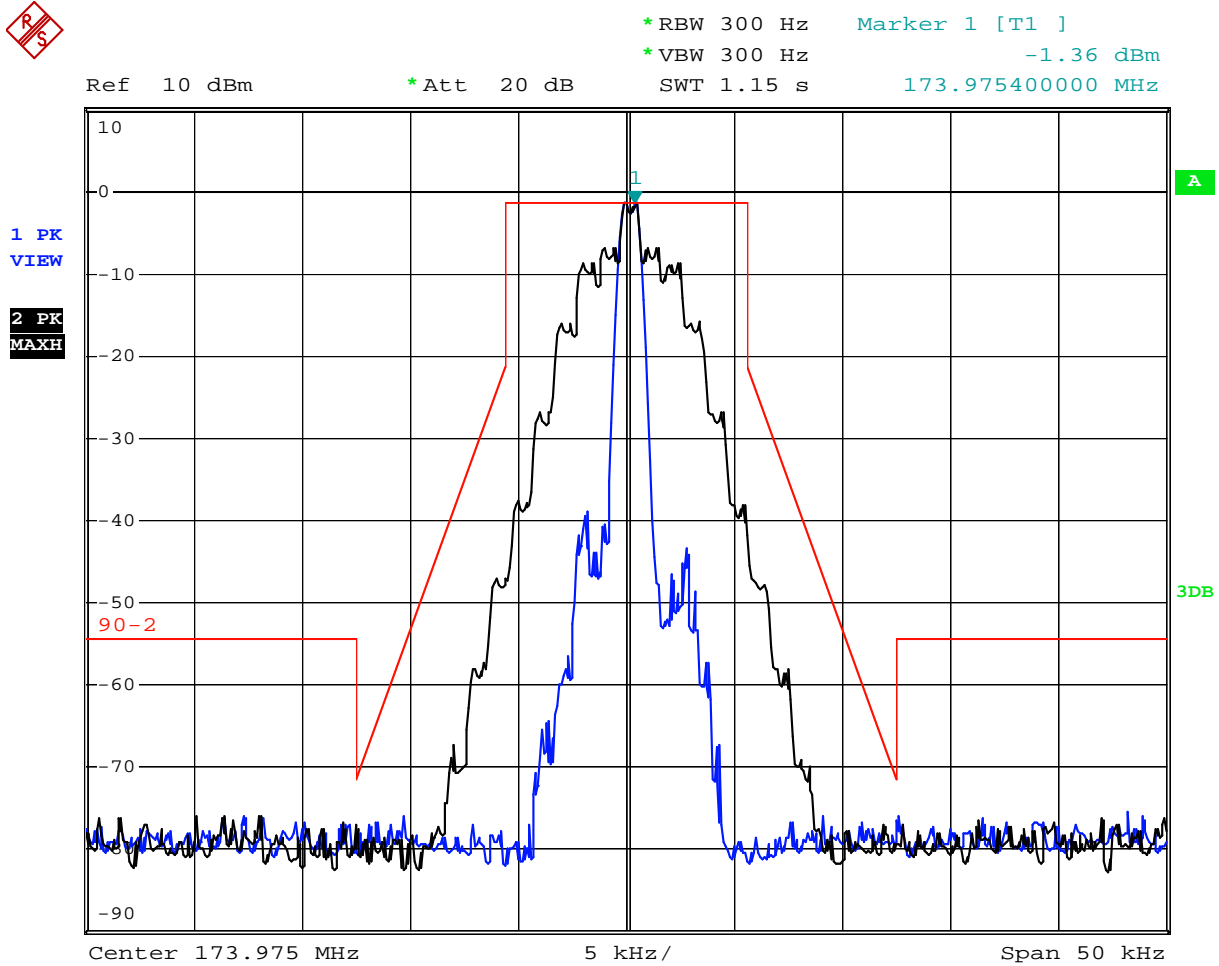

Date: 25.APR.2012 10:29:48

The report refers only to the sample tested and does not apply to the bulk.
This report is issued in confidence to the client and it will be strictly treated as such by the Shenzhen Timeway Technology Consulting Co.,Ltd. It may not be reproduced in its entirety or in part and it may not be used for advertising. The client to whom the report is issued may, however, show or send it or a certified copy thereof prepared by the Shenzhen Timeway Technology Consulting Co.,Ltd to his customer. Supplier or other persons directly concerned. Shenzhen Timeway Technology Consulting Co.,Ltd will not, without the consent of the client enter into any discussion of correspondence with any third party concerning the contents of the report.
In the event of the improper use of the report. The Shenzhen Timeway Technology Consulting Co.,Ltd reserves the rights to withdraw it and to adopt any other remedies which may be appropriate.



UHF Band-Top Channel

26dB Bandwidth



ndB DOWN VALUE
 26 dB
 Ref 10 dBm *Att 20 dB

*RBW 300 Hz Marker 1 [T1]
 *VBW 300 Hz -5.53 dBm
 SWT 1.15 s 479.97390000 MHz

1 PK
 VIEW

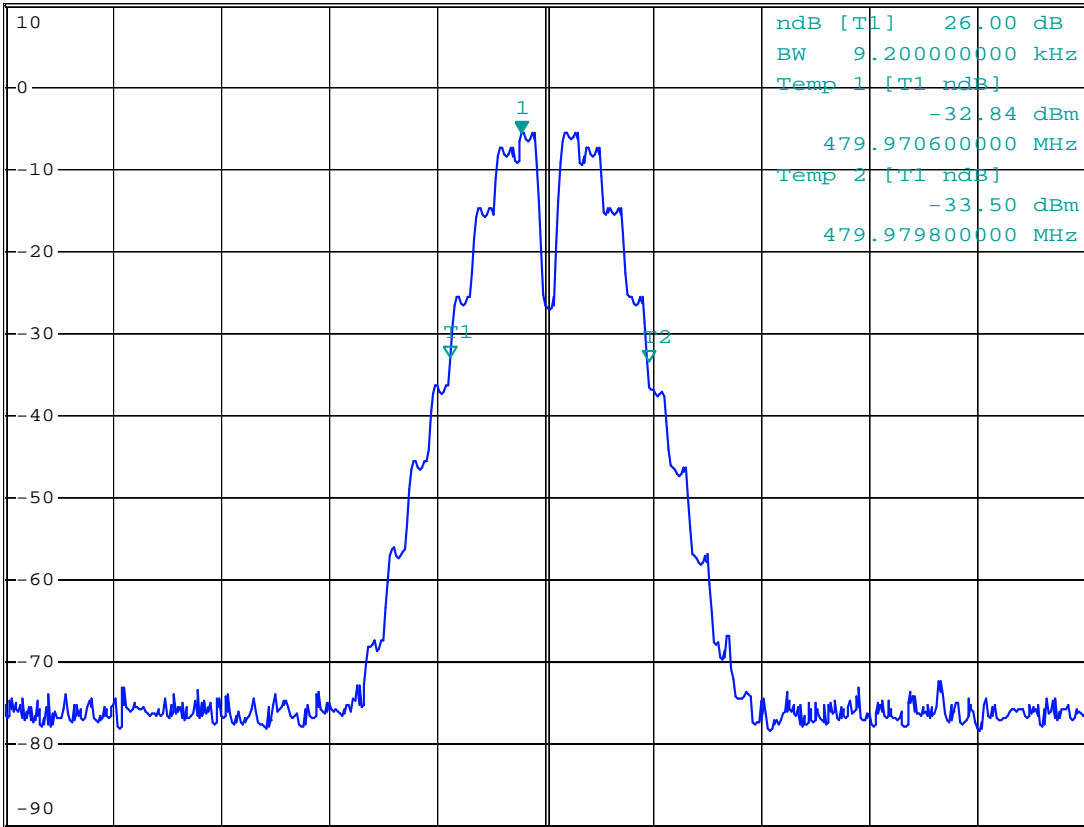

A

3DB

Center 479.975 MHz 5 kHz/ Span 50 kHz

Date: 25.APR.2012 10:44:18

The report refers only to the sample tested and does not apply to the bulk.
 This report is issued in confidence to the client and it will be strictly treated as such by the Shenzhen Timeway Technology Consulting Co.,Ltd. It may not be reproduced rather in its entirety or in part and it may not be used for adverting. The client to whom the report is issued may, however, show or send it . or a certified copy there of prepared by the Shenzhen Timeway Technology Consulting co.,Ltd to his customer. Supplier or others persons directly concerned. Shenzhen Timeway Technology Consulting co.,Ltd will not, without the consent of the client enter into any discussion of correspondence with any third party concerning the contents of the report.
 In the event of the improper use of the report. The Shenzhen Timeway Technology Consulting co.,Ltd reserves the rights to withdraw it and to adopt any other remedies which may be appropriate.



UHF Band-Top Channel

99% Bandwidth



MARKER 1
479.9739 MHz
Ref 10 dBm *Att 20 dB

*RBW 300 Hz Marker 1 [T1]
*VBW 300 Hz -5.53 dBm
SWT 1.15 s 479.973900000 MHz

1 PK
VIEW

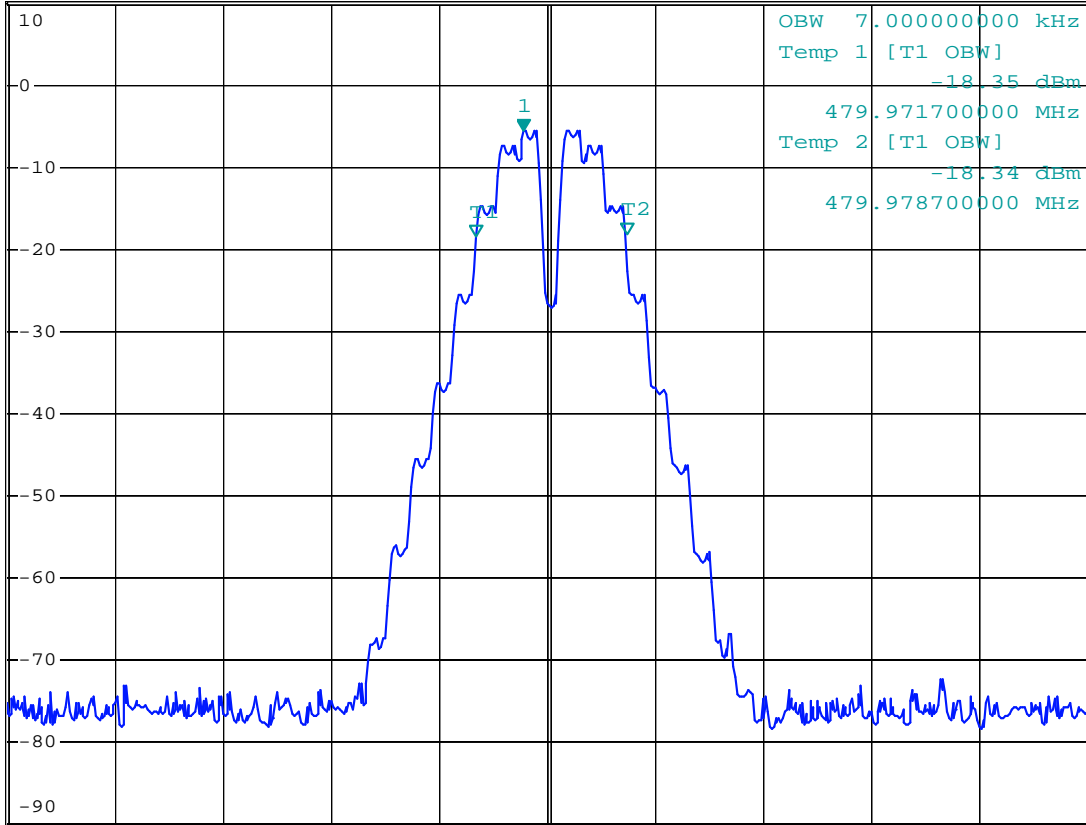

Center 479.975 MHz 5 kHz/ Span 50 kHz

Date: 25.APR.2012 10:43:57

The report refers only to the sample tested and does not apply to the bulk.
This report is issued in confidence to the client and it will be strictly treated as such by the Shenzhen Timeway Technology Consulting Co.,Ltd. It may not be reproduced rather in its entirety or in part and it may not be used for adverting. The client to whom the report is issued may, however, show or send it . or a certified copy there of prepared by the Shenzhen Timeway Technology Consulting co.,Ltd to his customer. Supplier or others persons directly concerned. Shenzhen Timeway Technology Consulting co.,Ltd will not, without the consent of the client enter into any discussion of correspondence with any third party concerning the contents of the report.
In the event of the improper use of the report. The Shenzhen Timeway Technology Consulting co.,Ltd reserves the rights to withdraw it and to adopt any other remedies which may be appropriate.



UHF Band-Top Channel

Emission Mask



*RBW 300 Hz Marker 1 [T1]
*VBW 300 Hz -0.07 dBm
Ref 10 dBm *Att 20 dB SWT 1.15 s 479.97500000 MHz

1 PK
VIEW

2 PK
VIEW

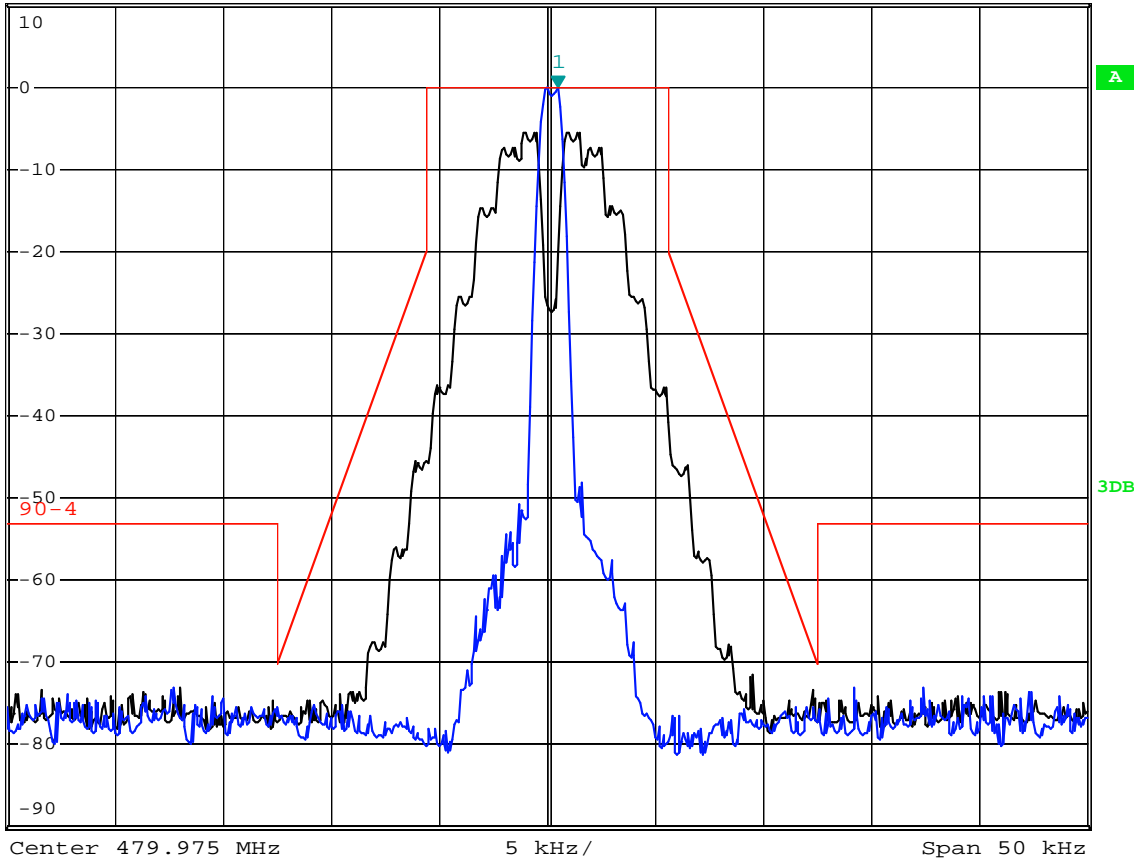

Date: 25.APR.2012 10:41:53

The report refers only to the sample tested and does not apply to the bulk.
This report is issued in confidence to the client and it will be strictly treated as such by the Shenzhen Timeway Technology Consulting Co.,Ltd. It may not be reproduced rather in its entirety or in part and it may not be used for advertising. The client to whom the report is issued may, however, show or send it or a certified copy thereof prepared by the Shenzhen Timeway Technology Consulting Co.,Ltd to his customer. Supplier or others persons directly concerned. Shenzhen Timeway Technology Consulting Co.,Ltd will not, without the consent of the client enter into any discussion of correspondence with any third party concerning the contents of the report.
In the event of the improper use of the report. The Shenzhen Timeway Technology Consulting Co.,Ltd reserves the rights to withdraw it and to adopt any other remedies which may be appropriate.



8. UNWANTED RADIATION

8.1 PROVISIONS APPLICABLE

8.1.1 According to Section 90.210, the power of each unwanted emission shall be less than Transmitted Power as specified below for transmitters designed to operate with 12.5 KHz channel bandwidth:

- (1) On any frequency from the centre of the authorized bandwidth f_0 to 5.625 KHz removed from f_0 :
Zero dB
- (2) On any frequency removed from the center of the authorized bandwidth by a displacement frequency (f_d in kHz) of more than 5.625 KHz but no more than 12.5 KHz: At least $7.27(f_d - 2.88 \text{ KHz})$ dB
- (3) On any frequency removed from the center of the authorized bandwidth by a displacement frequency (f_d in kHz) of more than 12.5 kHz: At least $50 + 10 \log(P)$ dB or 70 dB, whichever is the lesser attenuation.

8.2 MEASUREMENT PROCEDURE (Radiated Emissions)

- (1). On a test site, the EUT shall be placed on a turntable, and in the position closest to the normal use as declared by the user.
- (2). The test antenna shall be oriented initially for vertical polarization located 3m from the EUT to correspond to the transmitter.
- (3). The output of the antenna shall be connected to the measuring receiver and either a peak or quasi-peak detector was used for the measurement as indicated on the report. The detector selection is based on how close the emission level was approaching the limit.
- (4). The transmitter shall be switched on; if possible, without the modulation and the measurement receiver shall be tuned to the frequency of the transmitter under test.
- (5). The test antenna shall be raised and lowered through the specified range of height until the measuring receiver detects a maximum signal level.
- (6). The transmitter shall then be rotated through 360° in the horizontal plane, until the maximum signal level is detected by the measuring receiver.
- (7). The test antenna shall be raised and lowered again through the specified range of height until the measuring receiver detects a maximum signal level.
- (8). The maximum signal level detected by the measuring receiver shall be noted.
- (9). The measurement shall be repeated with the test antenna set to horizontal polarization.
- (10). Replace the antenna with a proper Antenna (substitution antenna).
- (11). The substitution antenna shall be oriented for vertical polarization and, if necessary, the length of the substitution antenna shall be adjusted to correspond to the frequency of transmitting.
- (12). The substitution antenna shall be connected to a calibrated signal generator.
- (13). If necessary, the input attenuator setting of the measuring receiver shall be adjusted in order to increase the sensitivity of the measuring receiver.
- (14). The test antenna shall be raised and lowered through the specified range of the height to ensure that the maximum signal is received.

The report refers only to the sample tested and does not apply to the bulk.

This report is issued in confidence to the client and it will be strictly treated as such by the Shenzhen Timeway Technology Consulting Co., Ltd. It may not be reproduced rather in its entirety or in part and it may not be used for advertising. The client to whom the report is issued may, however, show or send it, or a certified copy thereof prepared by the Shenzhen Timeway Technology Consulting Co., Ltd. to his customer. Supplier or other persons directly concerned. Shenzhen Timeway Technology Consulting Co., Ltd. will not, without the consent of the client enter into any discussion of correspondence with any third party concerning the contents of the report.

In the event of the improper use of the report. The Shenzhen Timeway Technology Consulting Co., Ltd. reserves the rights to withdraw it and to adopt any other remedies which may be appropriate.

(15). The input signal to substitution antenna shall be adjusted to the level that produces a level detected by the measuring receiver, that is equal to the level noted while the transmitter radiated power was measured, corrected for the change of input attenuation setting of the measuring receiver and Gain of Substitution antenna.

(16). The input level to the substitution antenna shall be recorded as power level in dBm, corrected for any change of input attenuator setting of the measuring receiver and Gain of Substitution antenna. So the EIRP is obtained.

(17). The measurement shall be repeated with the test antenna and the substitution antenna oriented for horizontal polarization.

8.3 Test setup Block Diagram

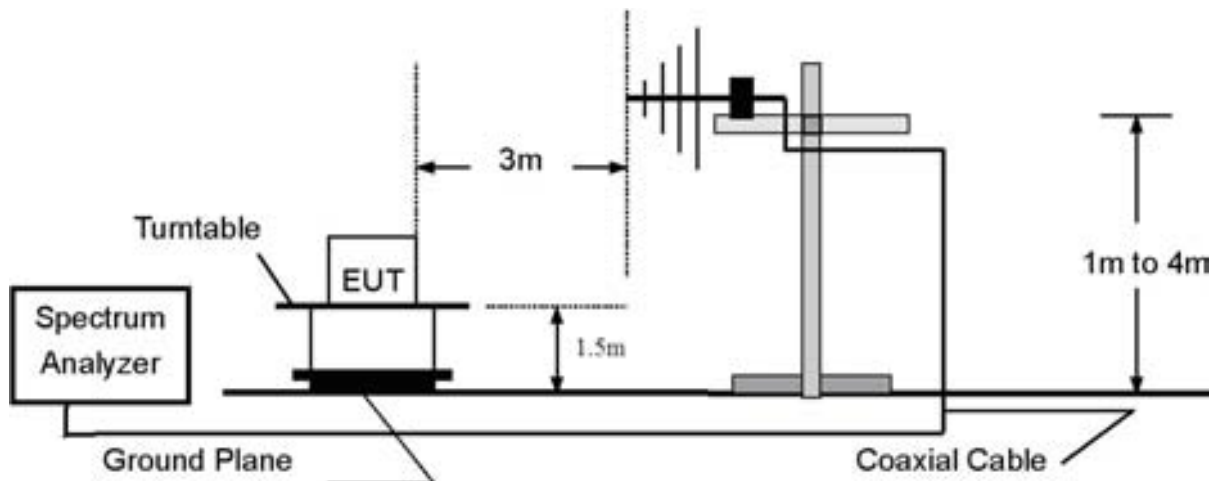

8.4 Substitution Method: (Radiated Emissions)

Radiated Below 1GHz

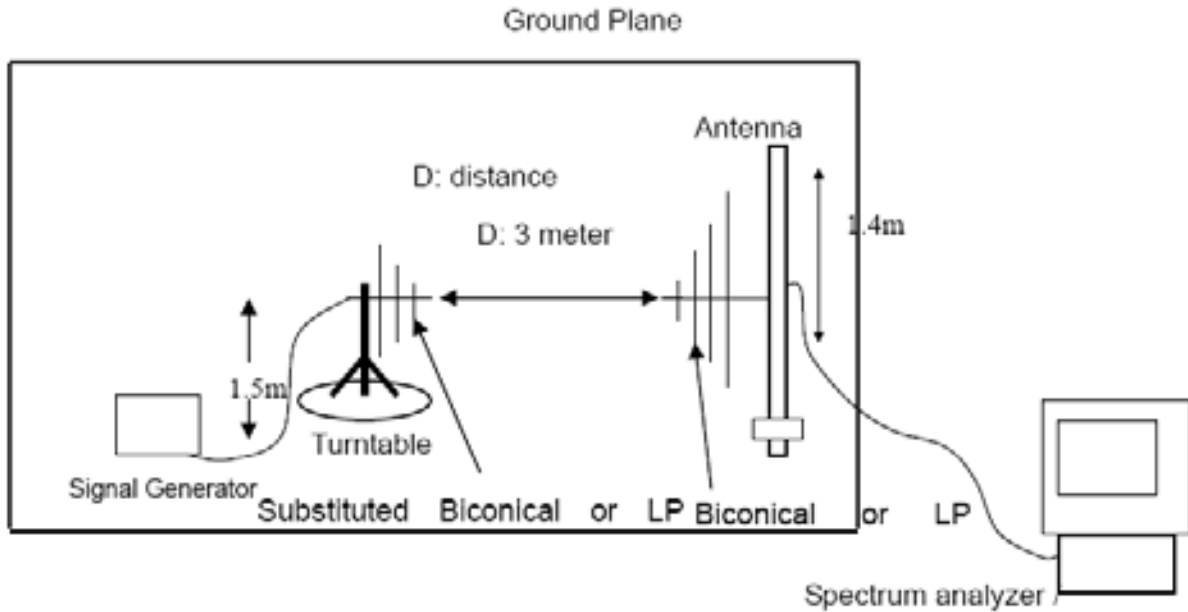

Radiated Above 1 GHz

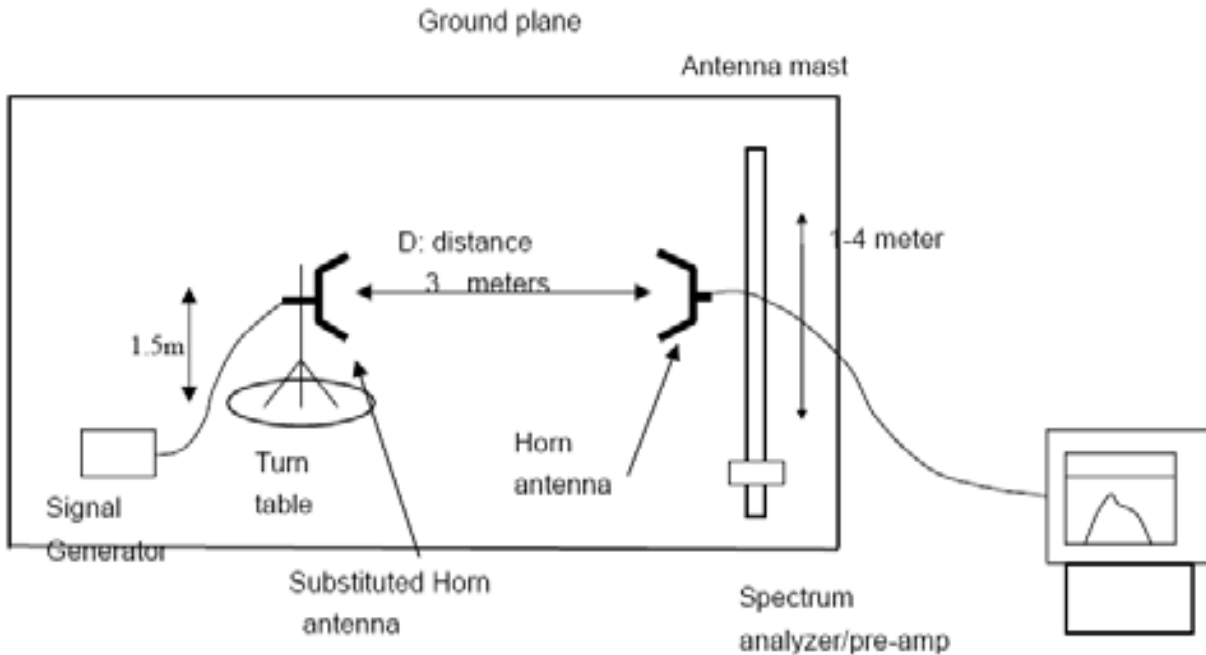

The report refers only to the sample tested and does not apply to the bulk.
This report is issued in confidence to the client and it will be strictly treated as such by the Shenzhen Timeway Technology Consulting Co., Ltd. It may not be reproduced in its entirety or in part and it may not be used for advertising. The client to whom the report is issued may, however, show or send it, or a certified copy thereof prepared by the Shenzhen Timeway Technology Consulting Co., Ltd. to his customer, supplier or other persons directly concerned. Shenzhen Timeway Technology Consulting Co., Ltd. will not, without the consent of the client, enter into any discussion of correspondence with any third party concerning the contents of the report.
In the event of the improper use of the report, the Shenzhen Timeway Technology Consulting Co., Ltd. reserves the rights to withdraw it and to adopt any other remedies which may be appropriate.



8.5 MEASUREMENT RESULTS:

Limit: $43 + 10 \log (P)$ dB, (-13 dBm)

Note: The results are peak values

VHF Band

Bottom channel

Frequency (MHz)	Antennal Polarity	Emission (dBm)	Limit (dBm)
272.05	Vertical	-36.2	-13
544.12	Vertical	-42.9	-13
272.05	Horizontal	-43.3	-13
544.12	Horizontal	-48.5	-13

Middle channel

Frequency (MHz)	Antennal Polarity	Emission (dBm)	Limit (dBm)
310.01	Vertical	-34.8	-13
620.01	Vertical	-43.6	-13
312.01	Horizontal	-38.2	-13
620.01	Horizontal	-45.5	-13

Top channel

Frequency (MHz)	Antennal Polarity	Emission (dBm)	Limit (dBm)
347.95	Vertical	-35.2	-13
521.93	Vertical	-44.7	-13
695.91	Vertical	-49.7	-13
347.95	Horizontal	-38.3	-13
521.93	Horizontal	-47.2	-13

The report refers only to the sample tested and does not apply to the bulk.

This report is issued in confidence to the client and it will be strictly treated as such by the Shenzhen Timeway Technology Consulting Co.,Ltd. It may not be reproduced rather in its entirety or in part and it may not be used for advertising. The client to whom the report is issued may, however, show or send it or a certified copy thereof prepared by the Shenzhen Timeway Technology Consulting Co.,Ltd to his customer. Supplier or others persons directly concerned. Shenzhen Timeway Technology Consulting Co.,Ltd will not, without the consent of the client enter into any discussion of correspondence with any third party concerning the contents of the report.

In the event of the improper use of the report. The Shenzhen Timeway Technology Consulting Co.,Ltd reserves the rights to withdraw it and to adopt any other remedies which may be appropriate.



UHF Band

Bottom channel

Frequency (MHz)	Antennal Polarity	Emission (dBm)	Limit (dBm)
800.05	Vertical	-39.9	-13
1200.13	Vertical	-47.5	-13
800.05	Horizontal	-41.3	-13
1200.12	Horizontal	-48.6	-13

Bottom channel

Frequency (MHz)	Antennal Polarity	Emission (dBm)	Limit (dBm)
880.01	Vertical	-37.8	-13
1320.03	Vertical	-45.2	-13
880.01	Horizontal	-39.5	-13
13020.03	Horizontal	-48.9	-13

Top channel

Frequency (MHz)	Antennal Polarity	Emission (dBm)	Limit (dBm)
959.95	Vertical	-35.2	-13
1439.93	Vertical	-43.2	-13
959.95	Horizontal	-38.9	-13
1439.93	Horizontal	-45.8	-13

The report refers only to the sample tested and does not apply to the bulk.

This report is issued in confidence to the client and it will be strictly treated as such by the Shenzhen Timeway Technology Consulting Co., Ltd. It may not be reproduced in its entirety or in part and it may not be used for advertising. The client to whom the report is issued may, however, show or send it, or a certified copy thereof prepared by the Shenzhen Timeway Technology Consulting Co., Ltd. to his customer, supplier or other persons directly concerned. Shenzhen Timeway Technology Consulting Co., Ltd. will not, without the consent of the client, enter into any discussion of correspondence with any third party concerning the contents of the report.

In the event of the improper use of the report, the Shenzhen Timeway Technology Consulting Co., Ltd. reserves the rights to withdraw it and to adopt any other remedies which may be appropriate.



8.6 Conducted Emissions

8.6.1. Measurement Procedure

- 1). The eut antenna port connect to the spectrum analyzer through a attenuator.
- 2). Let the eut working in transmitter and used the spectrum to measure the conducted emission.
- 3). The output of the antenna shall be connected to the spectrum.

The setup of test receiver: Detector: Peak RBW: 120kHz for 30-1000MHz ,1MHz for above1GHz
VBW: 300kHz for 30-1000MHz 3MHz for above1GHz

8.6.2. Test Setup Block Diagram (block diagram of configuration)



8.6.3 Test Result

VHF Band

Bottom Channel

Frequency (MHz)	Emission (dBm)	Limit (dBm)
272.05	-48.9	-13
408.08	-53.7	-13

Middle Channel

Frequency (MHz)	Emission (dBm)	Limit (dBm)
310.01	-48.3	-13
465.01	-54.7	-13

Top Channel

Frequency (MHz)	Emission (dBm)	Limit (dBm)
347.95	-50.2	-13
521.93	-54.2	-13

The report refers only to the sample tested and does not apply to the bulk.

This report is issued in confidence to the client and it will be strictly treated as such by the Shenzhen Timeway Technology Consulting Co., Ltd. It may not be reproduced rather in its entirety or in part and it may not be used for advertising. The client to whom the report is issued may, however, show or send it or a certified copy thereof prepared by the Shenzhen Timeway Technology Consulting Co., Ltd to his customer. Supplier or others persons directly concerned. Shenzhen Timeway Technology Consulting Co., Ltd will not, without the consent of the client enter into any discussion of correspondence with any third party concerning the contents of the report.

In the event of the improper use of the report. The Shenzhen Timeway Technology Consulting Co., Ltd reserves the rights to withdraw it and to adopt any other remedies which may be appropriate.



UHF Band

Bottom channel

Frequency (MHz)	Emission (dBm)	Limit (dBm)
800.05	-52.5	-13
1200.08	-59.6	-13

Middle channel

Frequency (MHz)	Emission (dBm)	Limit (dBm)
870.05	-49.9	-13
1305.08	-59.3	-13

Top Channel

Frequency (MHz)	Emission (dBm)	Limit (dBm)
959.95	-52.1	-13
1439.93	-59.3	-13

The report refers only to the sample tested and does not apply to the bulk.

This report is issued in confidence to the client and it will be strictly treated as such by the Shenzhen Timeway Technology Consulting Co., Ltd. It may not be reproduced in its entirety or in part and it may not be used for advertising. The client to whom the report is issued may, however, show or send it, or a certified copy thereof prepared by the Shenzhen Timeway Technology Consulting Co., Ltd. to his customer, supplier or other persons directly concerned. Shenzhen Timeway Technology Consulting Co., Ltd. will not, without the consent of the client, enter into any discussion of correspondence with any third party concerning the contents of the report.

In the event of the improper use of the report, the Shenzhen Timeway Technology Consulting Co., Ltd. reserves the rights to withdraw it and to adopt any other remedies which may be appropriate.



9. Modulation Characteristics

9.1 PROVISIONS APPLICABLE

According to CFR 47 section 2.1047(a), for Voice Modulation Communication Equipment, the frequency response of the audio modulation circuit over a range of 100 to 5000Hz shall be measured.

9.2 MEASUREMENT METHOD

9.2.1 Modulation Limit

- (1). Configure the EUT as shown in figure 1, adjust the audio input for 60% of rated system deviation at 1KHz using this level as a reference (0dB) and vary the input level from -20 to +20dB. Record the frequency deviation obtained as a function of the input level.
- (2). Repeat step 1 with input frequency changing to 300, 1000, 1500 and 3000Hz in sequence.

9.2.2 Audio Frequency Response

- (1). The EUT and test equipment were set up as shown in figure 2.
- (2). Adjust the Modulation Analyzer for the following setting:
 - a) High-pass filter : off
 - b) Low-pass filter : 15 kHz
 - c) Detector : positive peak
 - d) Function : FM
- (3). The audio signal input was adjusted to obtain 20 % modulation at 1 kHz, and this point was taken as the 0 dB reference level.
- (4). With input levels held constant and below limiting at all frequencies, the audio signal generator was varied from 300 Hz to 5 kHz.
- (5). The response in dB relative to 1 kHz was then measured, using the Modulation Analyzer.

The report refers only to the sample tested and does not apply to the bulk.

This report is issued in confidence to the client and it will be strictly treated as such by the Shenzhen Timeway Technology Consulting Co., Ltd. It may not be reproduced in its entirety or in part and it may not be used for advertising. The client to whom the report is issued may, however, show or send it, or a certified copy thereof prepared by the Shenzhen Timeway Technology Consulting Co., Ltd. to his customer, supplier or other persons directly concerned. Shenzhen Timeway Technology Consulting Co., Ltd. will not, without the consent of the client, enter into any discussion of correspondence with any third party concerning the contents of the report.

In the event of the improper use of the report, the Shenzhen Timeway Technology Consulting Co., Ltd. reserves the rights to withdraw it and to adopt any other remedies which may be appropriate.

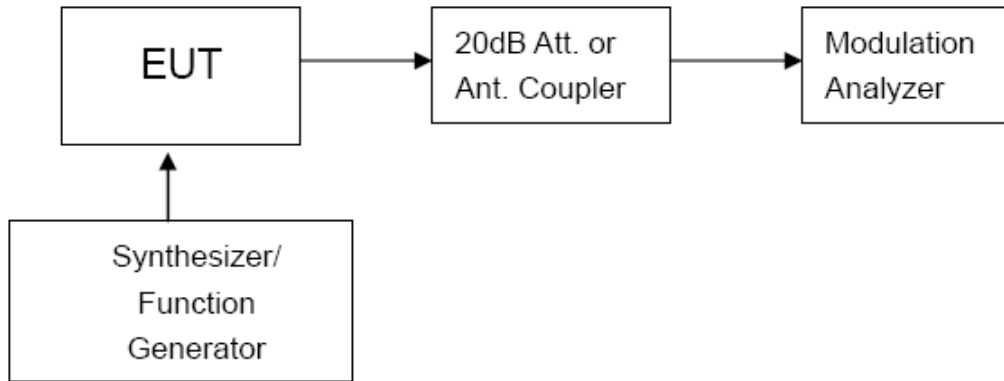

Figure 1: Modulation characteristic measurement configuration

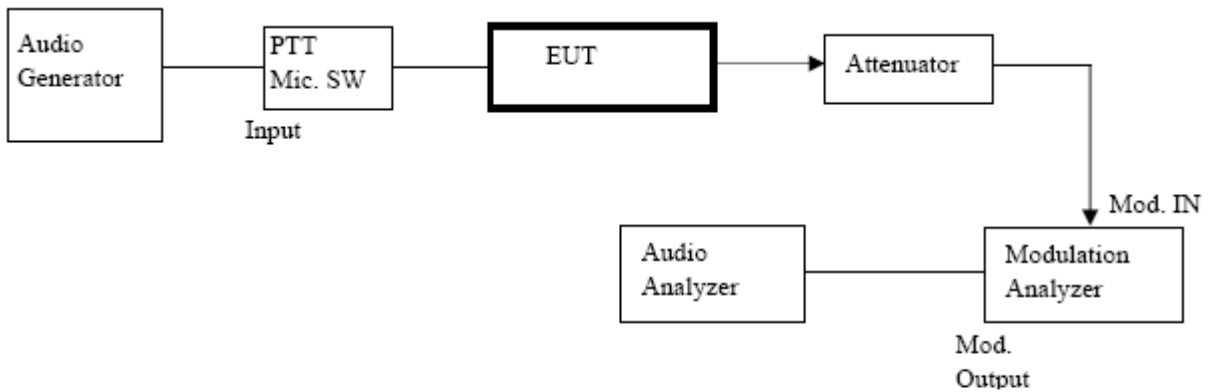

Figure 2: Audio Frequency Response Measurement Configure

The report refers only to the sample tested and does not apply to the bulk.
This report is issued in confidence to the client and it will be strictly treated as such by the Shenzhen Timeway Technology Consulting Co.,Ltd. It may not be reproduced rather in its entirety or in part and it may not be used for advertising. The client to whom the report is issued may, however, show or send it . or a certified copy there of prepared by the Shenzhen Timeway Technology Consulting co.,Ltd to his customer. Supplier or others persons directly concerned. Shenzhen Timeway Technology Consulting co.,Ltd will not, without the consent of the client enter into any discussion of correspondence with any third party concerning the contents of the report.
In the event of the improper use of the report. The Shenzhen Timeway Technology Consulting co.,Ltd reserves the rights to withdraw it and to adopt any other remedies which may be appropriate.



9.4 MEASUREMENT RESULT

(a). Modulation Limit:

Middle channel (For VHF Band)

Modulation Level (dB)	Peak Freq. Deviation At 300 Hz	Peak Freq. Deviation At 1000 Hz	Peak Freq. Deviation At 1500 Hz	Peak Freq. Deviation At 3000 Hz
-20	0.06	0.13	0.23	0.27
-15	0.07	0.20	0.30	0.51
-10	0.09	0.43	0.55	0.62
-5	0.12	0.66	0.93	1.17
0	0.16	1.25	1.41	1.62
+5	0.24	1.32	1.60	1.83
+10	0.34	1.52	1.77	1.89
+15	0.51	1.68	1.91	1.99
+20	0.65	1.85	2.09	2.10

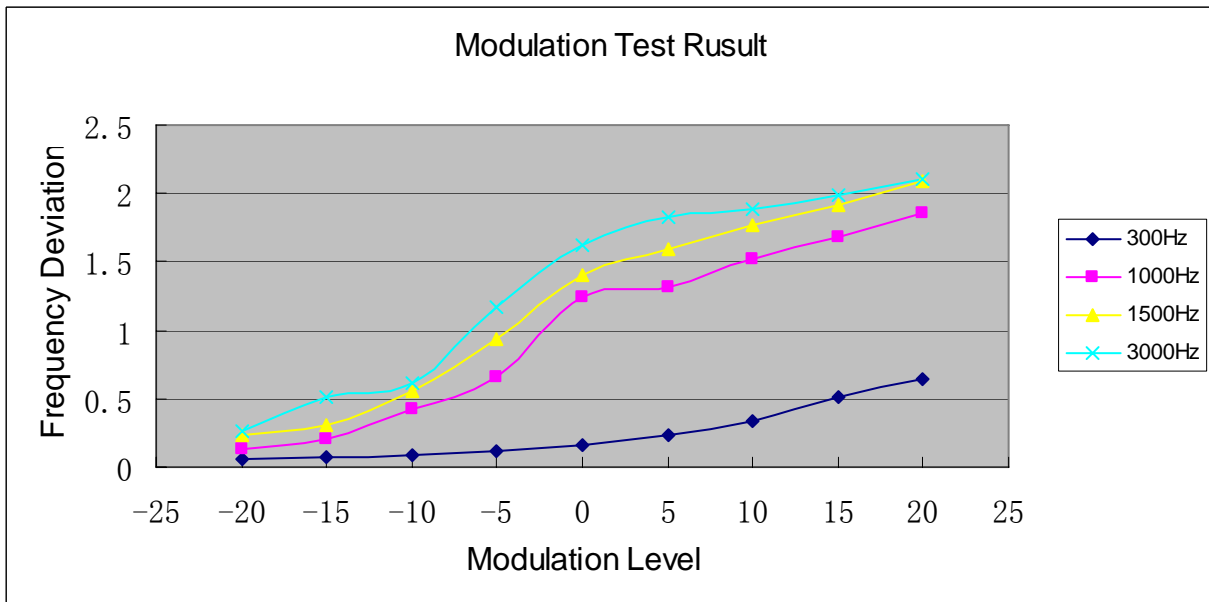

The report refers only to the sample tested and does not apply to the bulk.
 This report is issued in confidence to the client and it will be strictly treated as such by the Shenzhen Timeway Technology Consulting Co., Ltd. It may not be reproduced rather in its entirety or in part and it may not be used for advertising. The client to whom the report is issued may, however, show or send it, or a certified copy thereof prepared by the Shenzhen Timeway Technology Consulting Co., Ltd to his customer. Supplier or others persons directly concerned. Shenzhen Timeway Technology Consulting Co., Ltd will not, without the consent of the client enter into any discussion of correspondence with any third party concerning the contents of the report.
 In the event of the improper use of the report. The Shenzhen Timeway Technology Consulting Co., Ltd reserves the rights to withdraw it and to adopt any other remedies which may be appropriate.



(b). Audio Frequency Response:

For VHF Band

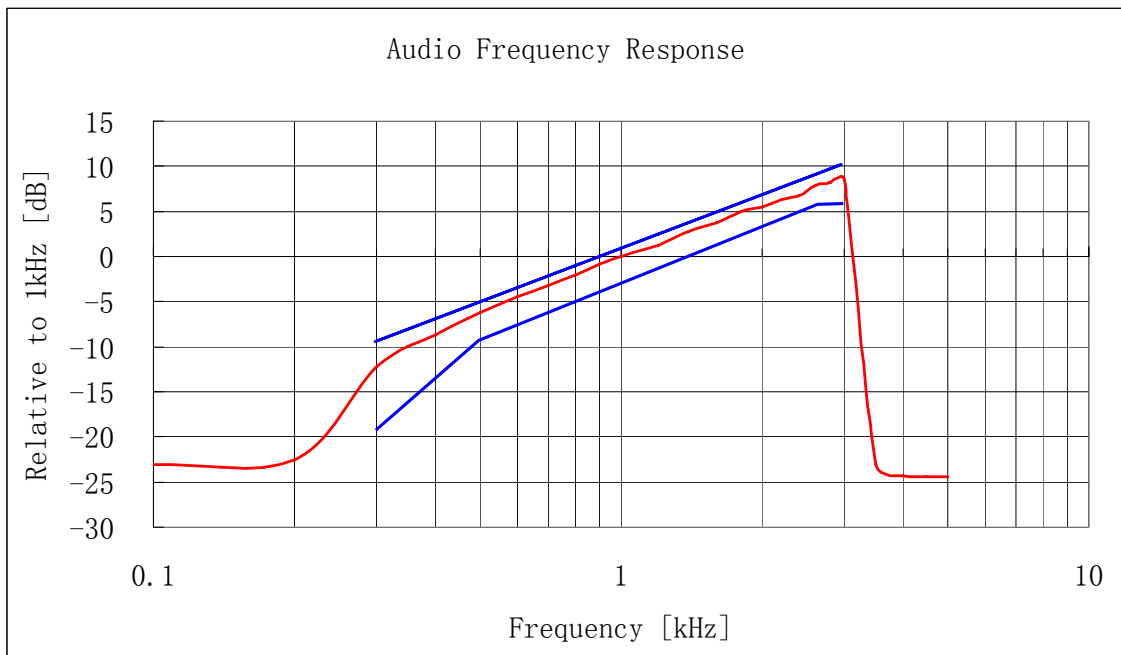

The report refers only to the sample tested and does not apply to the bulk.
This report is issued in confidence to the client and it will be strictly treated as such by the Shenzhen Timeway Technology Consulting Co., Ltd. It may not be reproduced in its entirety or in part and it may not be used for advertising. The client to whom the report is issued may, however, show or send it, or a certified copy thereof prepared by the Shenzhen Timeway Technology Consulting Co., Ltd. to his customer, supplier or other persons directly concerned. Shenzhen Timeway Technology Consulting Co., Ltd. will not, without the consent of the client, enter into any discussion of correspondence with any third party concerning the contents of the report.
In the event of the improper use of the report, the Shenzhen Timeway Technology Consulting Co., Ltd. reserves the rights to withdraw it and to adopt any other remedies which may be appropriate.



Middle channel (For UHF Band)

Modulation Level (dB)	Peak Freq. Deviation At 300 Hz	Peak Freq. Deviation At 1000 Hz	Peak Freq. Deviation At 1500 Hz	Peak Freq. Deviation At 3000 Hz
-20	0.05	0.22	0.32	0.35
-15	0.09	0.33	0.37	0.52
-10	0.11	0.53	0.61	0.72
-5	0.19	0.78	0.85	1.10
0	0.35	1.04	1.26	1.43
+5	0.48	1.16	1.55	1.76
+10	0.56	1.39	1.78	1.89
+15	0.63	1.56	1.92	2.10
+20	0.74	1.72	2.13	2.23

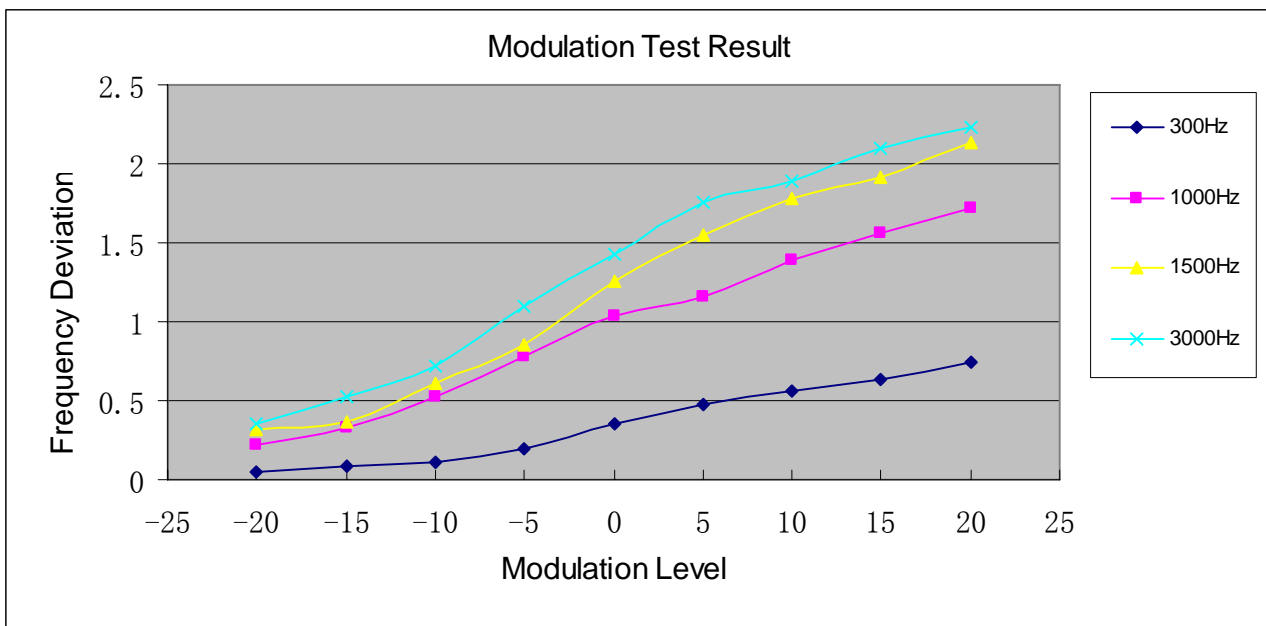

The report refers only to the sample tested and does not apply to the bulk.
 This report is issued in confidence to the client and it will be strictly treated as such by the Shenzhen Timeway Technology Consulting Co., Ltd. It may not be reproduced in its entirety or in part and it may not be used for advertising. The client to whom the report is issued may, however, show or send it, or a certified copy thereof prepared by the Shenzhen Timeway Technology Consulting Co., Ltd. to his customer, supplier or other persons directly concerned. Shenzhen Timeway Technology Consulting Co., Ltd. will not, without the consent of the client, enter into any discussion of correspondence with any third party concerning the contents of the report.
 In the event of the improper use of the report, the Shenzhen Timeway Technology Consulting Co., Ltd. reserves the rights to withdraw it and to adopt any other remedies which may be appropriate.



(b). Audio Frequency Response:

For UHF Band

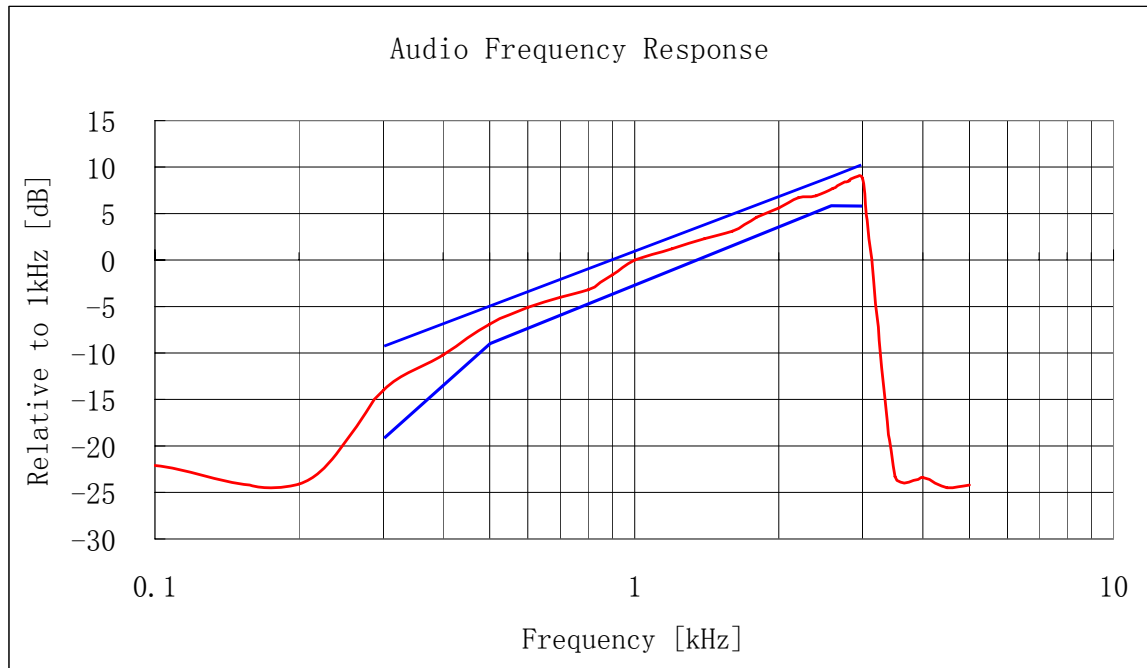

The report refers only to the sample tested and does not apply to the bulk.
This report is issued in confidence to the client and it will be strictly treated as such by the Shenzhen Timeway Technology Consulting Co., Ltd. It may not be reproduced in its entirety or in part and it may not be used for advertising. The client to whom the report is issued may, however, show or send it, or a certified copy thereof prepared by the Shenzhen Timeway Technology Consulting Co., Ltd. to his customer, supplier or other persons directly concerned. Shenzhen Timeway Technology Consulting Co., Ltd. will not, without the consent of the client, enter into any discussion of correspondence with any third party concerning the contents of the report.
In the event of the improper use of the report, the Shenzhen Timeway Technology Consulting Co., Ltd. reserves the rights to withdraw it and to adopt any other remedies which may be appropriate.



10. MAXIMUM TRANSMITTER POWER (CONDUCTED OUTPUT POWER)

10.1 PROVISIONS APPLICABLE

Per FCC §2.1046 and §90.205: Maximum EIRP is dependent upon the station's antenna HAAT and required service area.

10.2 TEST PROCEDURE

The RF output of Two-way Radio was conducted to a spectrum analyzer through an appropriate attenuator.

Spectrum analyzer setting: RBW=10kHz, VBW=30kHz, PK detector

10.3 TEST RESULT

Calculation Formula: $CP = R + A + L$

* Note:

CP: The final Conducted Power

R : The reading value from spectrum analyzer

A : The attenuation value of the used attenuator

L : The loss of all connection cables

Conducted Power Measurement Results		
Channel Separation	Channel	Measurement Result (dBm)
UHF Band	Bottom channel	31.51
	Top channel	31.45
VHF Band	Bottom channel	30.79
	Top channel	31.19

The report refers only to the sample tested and does not apply to the bulk.

This report is issued in confidence to the client and it will be strictly treated as such by the Shenzhen Timeway Technology Consulting Co., Ltd. It may not be reproduced in its entirety or in part and it may not be used for advertising. The client to whom the report is issued may, however, show or send it, or a certified copy thereof prepared by the Shenzhen Timeway Technology Consulting Co., Ltd. to his customer, supplier or other persons directly concerned. Shenzhen Timeway Technology Consulting Co., Ltd. will not, without the consent of the client, enter into any discussion of correspondence with any third party concerning the contents of the report.

In the event of the improper use of the report, the Shenzhen Timeway Technology Consulting Co., Ltd. reserves the rights to withdraw it and to adopt any other remedies which may be appropriate.



11. TRANSMITTER FREQUENCY BEHAVIOR

11.1 PROVISIONS APPLICABLE

Transmitters designed to operate in the 150–174 MHz and 421–512 MHz frequency bands must maintain transient frequencies within the maximum frequency difference limits during the time intervals indicated:

t_3 is the time period from the instant when the transmitter is turned off until t_{off} .

t_{off} is the instant when the 1 kHz test signal starts to rise.

² During the time from the end of t_2 to the beginning of t_3 , the frequency difference must not exceed the limits specified in § 90.213.

Time intervals ^{1,2}	Maximum frequency difference ³	All equipment	
		150 to 174 MHz	421 to 512 MHz

Transient Frequency Behavior for Equipment Designed to Operate on 25 kHz Channels

t_1 ⁴	±25.0 kHz	5.0 ms	10.0 ms
t_2	±12.5 kHz	20.0 ms	25.0 ms
t_3 ⁴	±25.0 kHz	5.0 ms	10.0 ms

Transient Frequency Behavior for Equipment Designed to Operate on 12.5 kHz Channels

t_1 ⁴	±12.5 kHz	5.0 ms	10.0 ms
t_2	±6.25 kHz	20.0 ms	25.0 ms
t_3 ⁴	±12.5 kHz	5.0 ms	10.0 ms

Transient Frequency Behavior for Equipment Designed to Operate on 6.25 kHz Channels

t_1 ⁴	±6.25 kHz	5.0 ms	10.0 ms
t_2	±3.125 kHz	20.0 ms	25.0 ms
t_3 ⁴	±6.25 kHz	5.0 ms	10.0 ms

¹_{on} is the instant when a 1 kHz test signal is completely suppressed, including any capture time due to phasing.

t_1 is the time period immediately following t_{on} .

t_2 is the time period immediately following t_1 .

The report refers only to the sample tested and does not apply to the bulk.

This report is issued in confidence to the client and it will be strictly treated as such by the Shenzhen Timeway Technology Consulting Co., Ltd. It may not be reproduced in its entirety or in part and it may not be used for advertising. The client to whom the report is issued may, however, show or send it, or a certified copy thereof prepared by the Shenzhen Timeway Technology Consulting Co., Ltd. to his customer. Supplier or other persons directly concerned. Shenzhen Timeway Technology Consulting Co., Ltd. will not, without the consent of the client enter into any discussion of correspondence with any third party concerning the contents of the report.

In the event of the improper use of the report, the Shenzhen Timeway Technology Consulting Co., Ltd. reserves the rights to withdraw it and to adopt any other remedies which may be appropriate.



t_3 is the time period from the instant when the transmitter is turned off until t_{off} .

t_{off} is the instant when the 1 kHz test signal starts to rise.

² During the time from the end of t_2 to the beginning of t_3 , the frequency difference must not exceed the limits specified in § 90.213.

³ Difference between the actual transmitter frequency and the assigned transmitter frequency.

⁴ If the transmitter carrier output power rating is 6 watts or less, the frequency difference during this time period may exceed the maximum frequency difference for this time period.

11.2 Test Method

TIA/EIA-603 2.2.19

11.3 Test setup Block Diagram

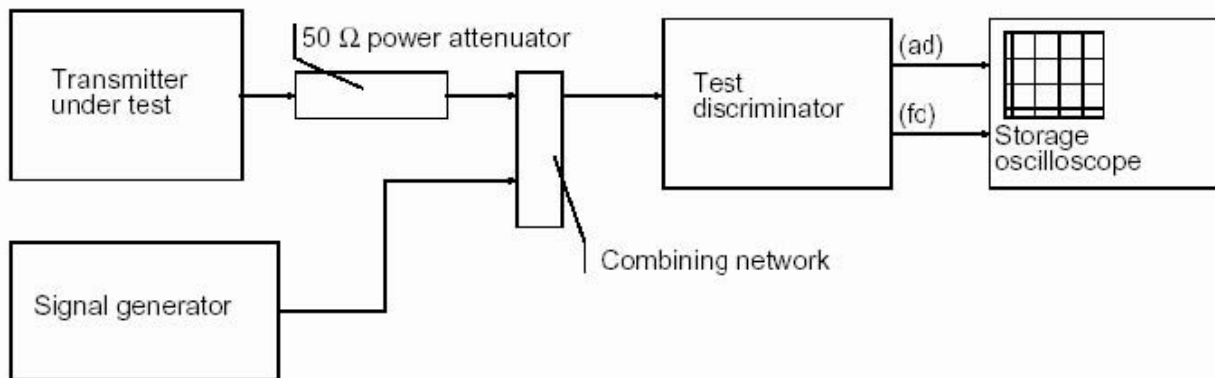

11.4 MEASURE RESULT

The report refers only to the sample tested and does not apply to the bulk.

This report is issued in confidence to the client and it will be strictly treated as such by the Shenzhen Timeway Technology Consulting Co., Ltd. It may not be reproduced in its entirety or in part and it may not be used for advertising. The client to whom the report is issued may, however, show or send it, or a certified copy thereof prepared by the Shenzhen Timeway Technology Consulting Co., Ltd. to his customer. Supplier or other persons directly concerned. Shenzhen Timeway Technology Consulting Co., Ltd. will not, without the consent of the client enter into any discussion of correspondence with any third party concerning the contents of the report.

In the event of the improper use of the report, The Shenzhen Timeway Technology Consulting Co., Ltd reserves the rights to withdraw it and to adopt any other remedies which may be appropriate.



Transmitter Frequency Behaviour @ 12.5 KHz Channel Separation--Off to On at VHF Band

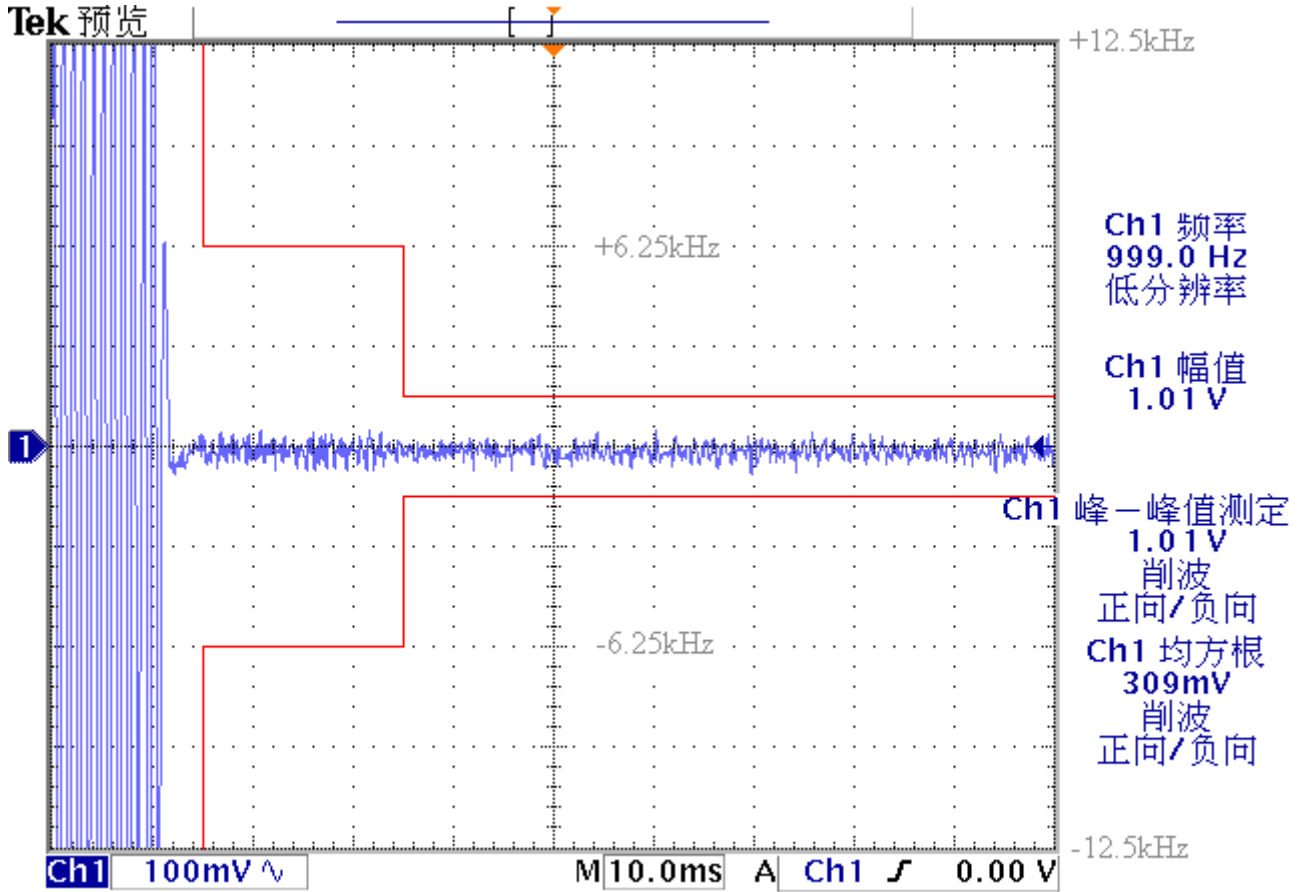

The report refers only to the sample tested and does not apply to the bulk.
This report is issued in confidence to the client and it will be strictly treated as such by the Shenzhen Timeway Technology Consulting Co., Ltd. It may not be reproduced rather in its entirety or in part and it may not be used for advertising. The client to whom the report is issued may, however, show or send it, or a certified copy thereof prepared by the Shenzhen Timeway Technology Consulting Co., Ltd to his customer. Supplier or others persons directly concerned. Shenzhen Timeway Technology Consulting Co., Ltd will not, without the consent of the client enter into any discussion of correspondence with any third party concerning the contents of the report.
In the event of the improper use of the report. The Shenzhen Timeway Technology Consulting Co., Ltd reserves the rights to withdraw it and to adopt any other remedies which may be appropriate.



Transmitter Frequency Behaviour @ 12.5 KHz Channel Separation—On to Off at VHF Band

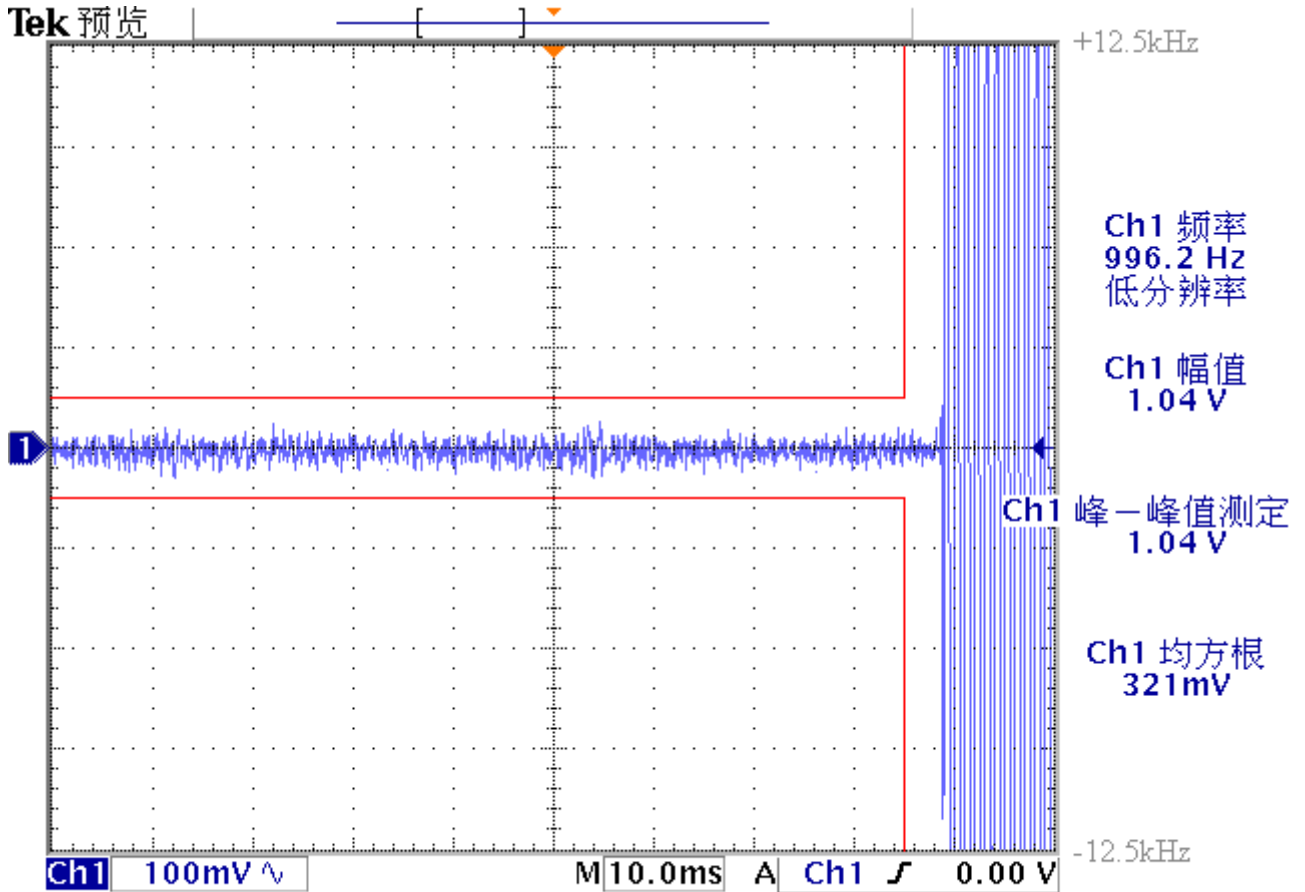

The report refers only to the sample tested and does not apply to the bulk.
This report is issued in confidence to the client and it will be strictly treated as such by the Shenzhen Timeway Technology Consulting Co., Ltd. It may not be reproduced in its entirety or in part and it may not be used for advertising. The client to whom the report is issued may, however, show or send it, or a certified copy thereof prepared by the Shenzhen Timeway Technology Consulting Co., Ltd. to his customer, supplier or other persons directly concerned. Shenzhen Timeway Technology Consulting Co., Ltd. will not, without the consent of the client, enter into any discussion of correspondence with any third party concerning the contents of the report.
In the event of the improper use of the report, the Shenzhen Timeway Technology Consulting Co., Ltd. reserves the rights to withdraw it and to adopt any other remedies which may be appropriate.



Transmitter Frequency Behaviour @ 12.5 kHz Channel Separation--Off to On at UHF Band

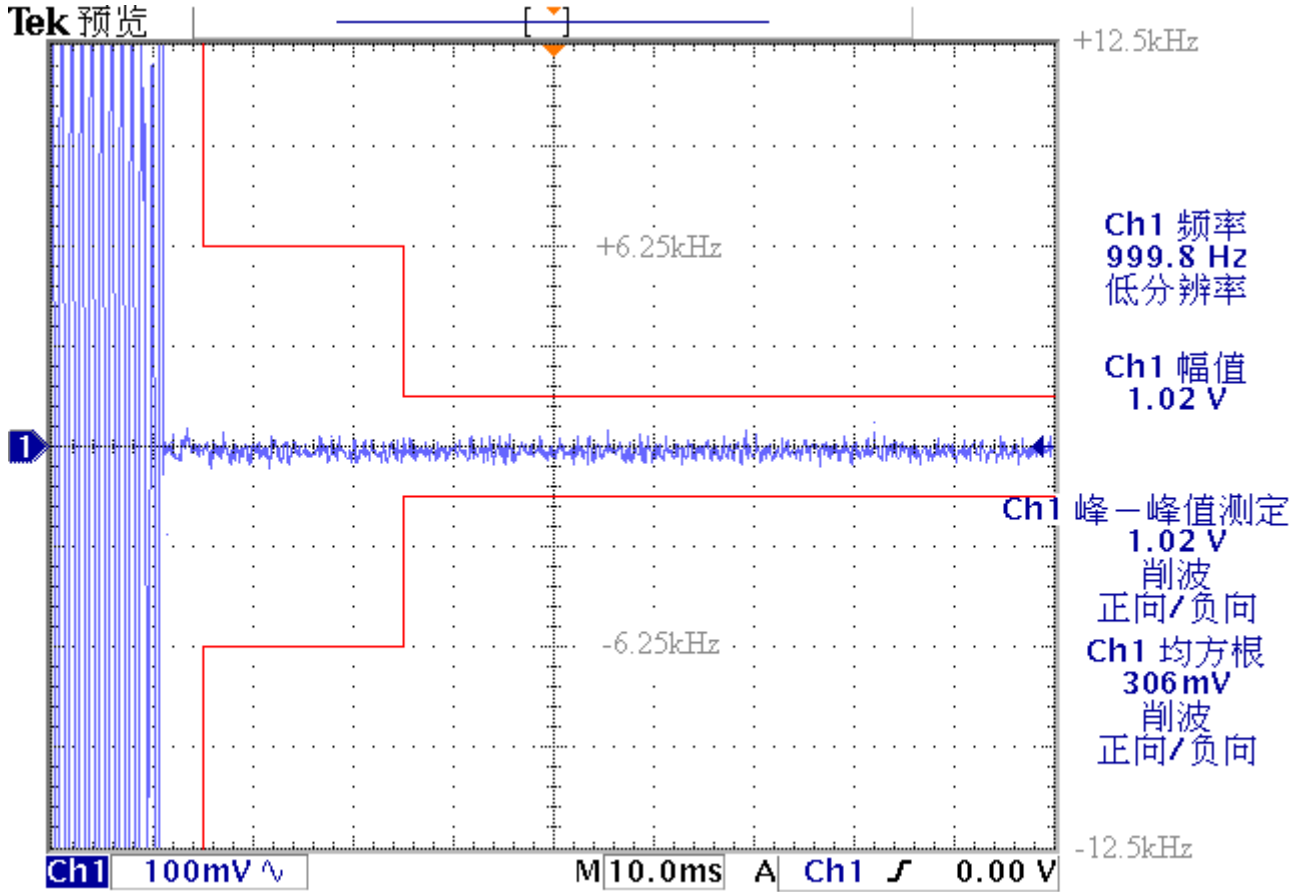

The report refers only to the sample tested and does not apply to the bulk.
This report is issued in confidence to the client and it will be strictly treated as such by the Shenzhen Timeway Technology Consulting Co., Ltd. It may not be reproduced in its entirety or in part and it may not be used for advertising. The client to whom the report is issued may, however, show or send it, or a certified copy thereof prepared by the Shenzhen Timeway Technology Consulting Co., Ltd. to his customer, supplier or other persons directly concerned. Shenzhen Timeway Technology Consulting Co., Ltd. will not, without the consent of the client enter into any discussion of correspondence with any third party concerning the contents of the report.
In the event of the improper use of the report, the Shenzhen Timeway Technology Consulting Co., Ltd. reserves the rights to withdraw it and to adopt any other remedies which may be appropriate.



Transmitter Frequency Behaviour @ 12.5 kHz Channel Separation—On to Off at UHF Band

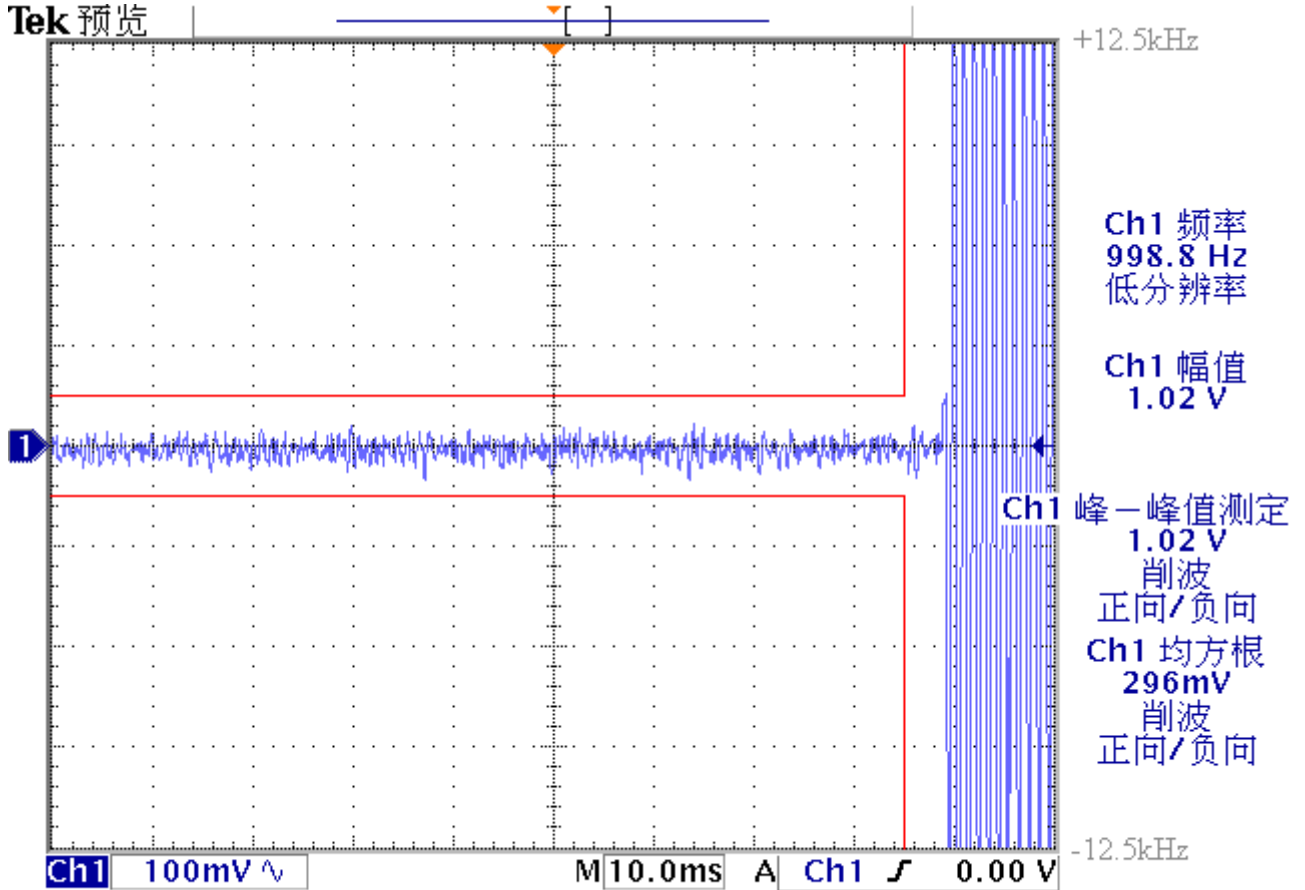

The report refers only to the sample tested and does not apply to the bulk.
This report is issued in confidence to the client and it will be strictly treated as such by the Shenzhen Timeway Technology Consulting Co., Ltd. It may not be reproduced in its entirety or in part and it may not be used for advertising. The client to whom the report is issued may, however, show or send it, or a certified copy thereof prepared by the Shenzhen Timeway Technology Consulting Co., Ltd. to his customer, supplier or other persons directly concerned. Shenzhen Timeway Technology Consulting Co., Ltd. will not, without the consent of the client, enter into any discussion of correspondence with any third party concerning the contents of the report.
In the event of the improper use of the report, the Shenzhen Timeway Technology Consulting Co., Ltd. reserves the rights to withdraw it and to adopt any other remedies which may be appropriate.



12. Radiated Emission on Receiving Mode

12.1 Provisions Applicable

FCC Part 15 Subpart B Section 15.109

12.2 TEST METHOD

ANSI C 63.4: 2003

12.4 MEASURE RESULT (MEASURED AT 3M USING FCC PART15 B LIMITS)

The report refers only to the sample tested and does not apply to the bulk.

This report is issued in confidence to the client and it will be strictly treated as such by the Shenzhen Timeway Technology Consulting Co.,Ltd. It may not be reproduced in its entirety or in part and it may not be used for advertising. The client to whom the report is issued may, however, show or send it or a certified copy thereof prepared by the Shenzhen Timeway Technology Consulting Co.,Ltd to his customer. Supplier or other persons directly concerned. Shenzhen Timeway Technology Consulting Co.,Ltd will not, without the consent of the client enter into any discussion of correspondence with any third party concerning the contents of the report.

In the event of the improper use of the report. The Shenzhen Timeway Technology Consulting Co.,Ltd reserves the rights to withdraw it and to adopt any other remedies which may be appropriate.



Radiated Emission In Horizontal (30MHz----1000MHz)

EUT set Condition: Keep Tx Transmitting

Operation Mode:

Results: Pass

Please refer to following diagram for individual

MARKER 1
 118.08 MHz
 Att 10 dB
 RBW 120 kHz Marker 1 [T1]
 MT 50 μs 22.96 dBμV/m
 PREAMP ON 118.08000000 MHz

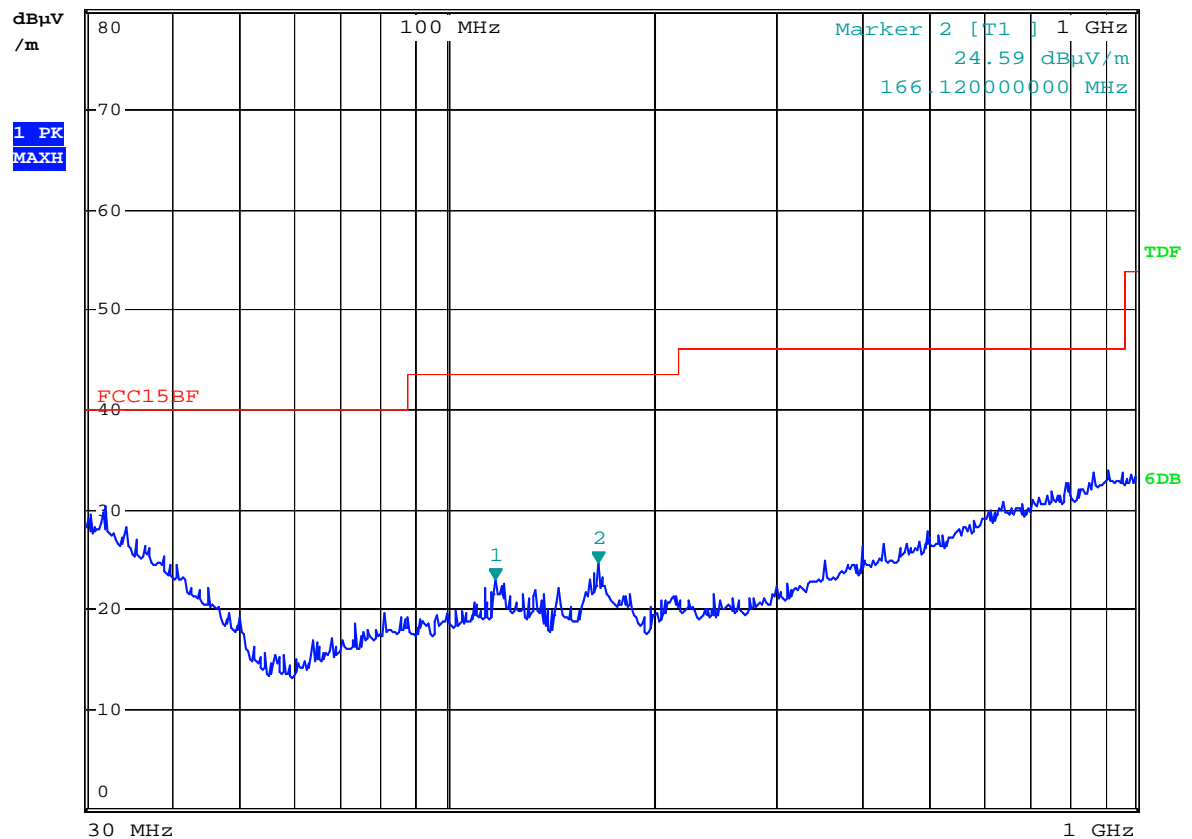

Date: 6.APR.2012 13:25:11

Frequency (MHz)	Level@3m (dB μ V/m)	Antenna Polarity	Limit@3m (dB μ V/m)
118.080	22.96	H	43.50
166.120	24.59	H	43.50

The report refers only to the sample tested and does not apply to the bulk. This report is issued in confidence to the client and it will be strictly treated as such by the Shenzhen Timeway Technology Consulting Co.,Ltd. It may not be reproduced rather in its entirety or in part and it may not be used for advertising. The client to whom the report is issued may, however, show or send it . or a certified copy there of prepared by the Shenzhen Timeway Technology Consulting co.,Ltd to his customer. Supplier or others persons directly concerned. Shenzhen Timeway Technology Consulting co.,Ltd will not, without the consent of the client enter into any discussion of correspondence with any third party concerning the contents of the report. In the event of the improper use of the report. The Shenzhen Timeway Technology Consulting co.,Ltd reserves the rights to withdraw it and to adopt any other remedies which may be appropriate.



Radiated Emission In Vertical (30MHz----1000MHz)

EUT set Condition: Charging and Receiving

Results: Pass

Please refer to following diagram for individual

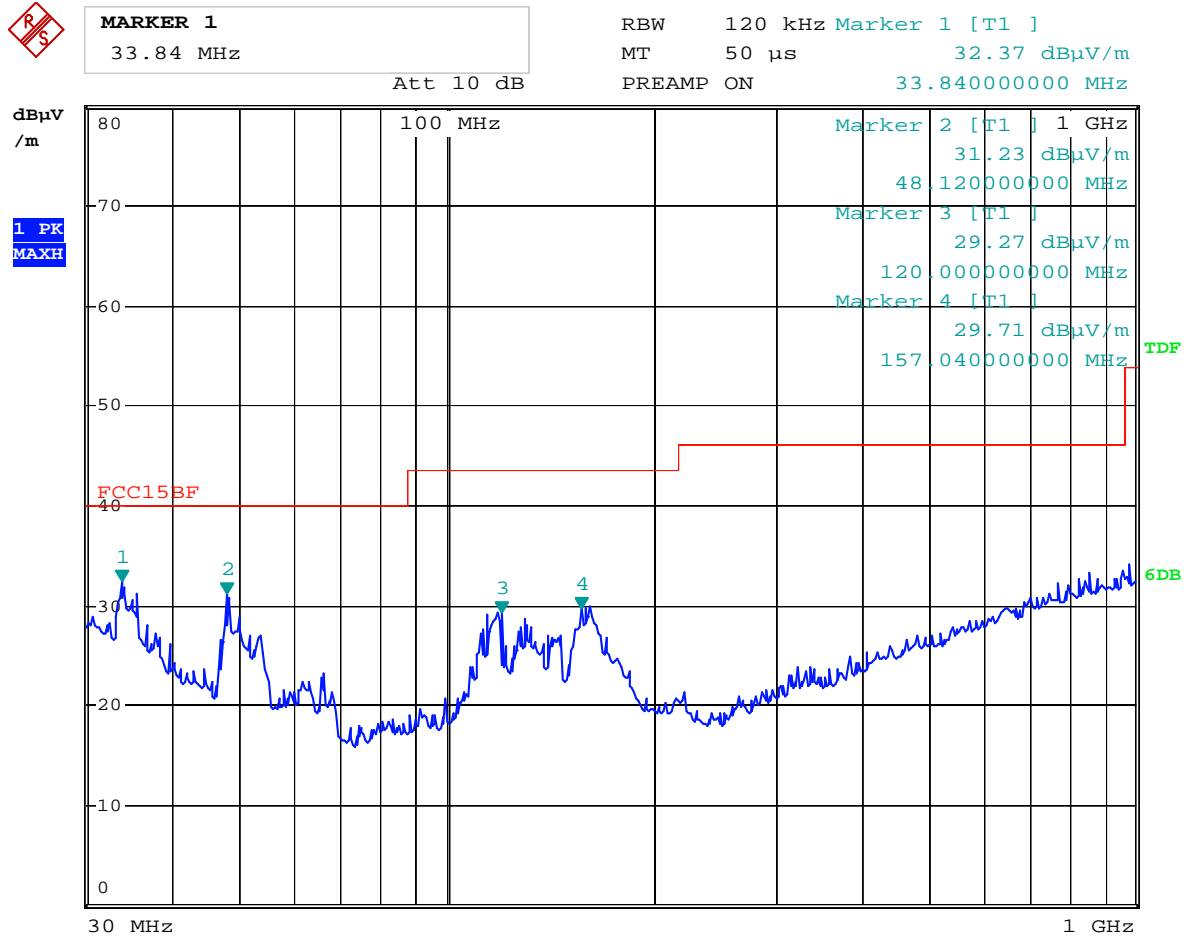

Date: 6.APR.2012 13:30:23

Frequency (MHz)	Level@3m (dB µ V/m)	Antenna Polarity	Limit@3m (dB µ V/m)
33.840	32.37	V	40.00
48.120	31.23	V	40.00
120.000	29.27	V	43.50
157.040	29.71	V	43.50

The report refers only to the sample tested and does not apply to the bulk.
This report is issued in confidence to the client and it will be strictly treated as such by the Shenzhen Timeway Technology Consulting Co.,Ltd. It may not be reproduced rather in its entirety or in part and it may not be used for advertising. The client to whom the report is issued may, however, show or send it . or a certified copy there of prepared by the Shenzhen Timeway Technology Consulting co.,Ltd to his customer. Supplier or others persons directly concerned. Shenzhen Timeway Technology Consulting co.,Ltd will not, without the consent of the client enter into any discussion of correspondence with any third party concerning the contents of the report.
In the event of the improper use of the report. The Shenzhen Timeway Technology Consulting co.,Ltd reserves the rights to withdraw it and to adopt any other remedies which may be appropriate.



13.0 RF Exposure

The threshold levels for SAR of PTT devices are given in Section 5 of KDB447498.

For held to face configuration the power threshold is 250mW. For occupational use the power is increased by a factor of five. For this PTT device, the maximum duty cycle is 50%. This results in a maximum peak power of 1.25W for held to face configuration.

For body worn operation a power threshold according to table 1 of KDB447498 applies. The power threshold for body worn devices with 1.5cm distance is 200mW. For occupational use a factor of five is applied and a duty factor of 50% can be assumed. This results in a power threshold of 1W.

The device with half of maximum power of 0.891W which is less than the power threshold of 1W and maximum duty cycle of 50% and frequencies below 500MHz can be certified without SAR test according to the above considerations.

Note: The value of 0.891W is the half of calculated EIRP with 100% duty cycle

Maximum EIRP=31.51+antenna Gain=31.51+1.0dBi=32.51dBm (UHF Band)

Maximum EIRP=31.19+antenna Gain=31.19+1.0dBi=32.19dBm (VHF Band)

The report refers only to the sample tested and does not apply to the bulk.

This report is issued in confidence to the client and it will be strictly treated as such by the Shenzhen Timeway Technology Consulting Co., Ltd. It may not be reproduced in its entirety or in part and it may not be used for advertising. The client to whom the report is issued may, however, show or send it, or a certified copy thereof prepared by the Shenzhen Timeway Technology Consulting Co., Ltd to his customer. Supplier or other persons directly concerned. Shenzhen Timeway Technology Consulting Co., Ltd will not, without the consent of the client enter into any discussion of correspondence with any third party concerning the contents of the report.

In the event of the improper use of the report, The Shenzhen Timeway Technology Consulting Co., Ltd reserves the rights to withdraw it and to adopt any other remedies which may be appropriate.



14.0 FCC ID Label

FCC ID: ZP5BF-5R

This device complies with part 15 and 90 of the FCC rules. Operation is subject to the following two conditions (1) this device may not cause harmful interference, and (2) this device must accept any interference received, including interference that may cause undesired operation.

The label must not be a stick-on paper label. The label on these products must be permanently affixed to the product and readily visible at the time of purchase and must last the expected lifetime of the equipment not be readily detachable.

Mark Location:

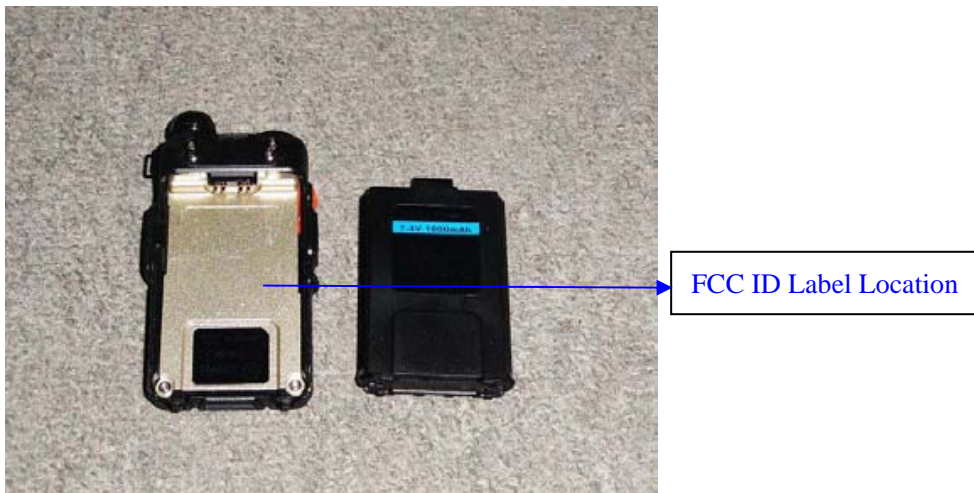

15.0 Photo of testing

15.1 Conducted test View--



15.2 Radiated emission test view



The report refers only to the sample tested and does not apply to the bulk.

This report is issued in confidence to the client and it will be strictly treated as such by the Shenzhen Timeway Technology Consulting Co., Ltd. It may not be reproduced in its entirety or in part and it may not be used for advertising. The client to whom the report is issued may, however, show or send it, or a certified copy thereof prepared by the Shenzhen Timeway Technology Consulting Co., Ltd. to his customer. Supplier or other persons directly concerned. Shenzhen Timeway Technology Consulting Co., Ltd. will not, without the consent of the client enter into any discussion of correspondence with any third party concerning the contents of the report.

In the event of the improper use of the report, the Shenzhen Timeway Technology Consulting Co., Ltd. reserves the rights to withdraw it and to adopt any other remedies which may be appropriate.

Spurious Radiated Emissions test View--



Spurious Radiated Emissions test View--



The report refers only to the sample tested and does not apply to the bulk.
This report is issued in confidence to the client and it will be strictly treated as such by the Shenzhen Timeway Technology Consulting Co., Ltd. It may not be reproduced in its entirety or in part and it may not be used for advertising. The client to whom the report is issued may, however, show or send it, or a certified copy thereof prepared by the Shenzhen Timeway Technology Consulting Co., Ltd. to his customer, supplier or other persons directly concerned. Shenzhen Timeway Technology Consulting Co., Ltd. will not, without the consent of the client, enter into any discussion of correspondence with any third party concerning the contents of the report.
In the event of the improper use of the report, the Shenzhen Timeway Technology Consulting Co., Ltd. reserves the rights to withdraw it and to adopt any other remedies which may be appropriate.

Outside View



The report refers only to the sample tested and does not apply to the bulk.
This report is issued in confidence to the client and it will be strictly treated as such by the Shenzhen Timeway Technology Consulting Co.,Ltd. It may not be reproduced rather in its entirety or in part and it may not be used for advertising. The client to whom the report is issued may, however, show or send it, or a certified copy thereof prepared by the Shenzhen Timeway Technology Consulting Co.,Ltd to his customer. Supplier or other persons directly concerned. Shenzhen Timeway Technology Consulting Co.,Ltd will not, without the consent of the client enter into any discussion of correspondence with any third party concerning the contents of the report.
In the event of the improper use of the report. The Shenzhen Timeway Technology Consulting Co.,Ltd reserves the rights to withdraw it and to adopt any other remedies which may be appropriate.

Outside View



The report refers only to the sample tested and does not apply to the bulk.
This report is issued in confidence to the client and it will be strictly treated as such by the Shenzhen Timeway Technology Consulting Co.,Ltd. It may not be reproduced rather in its entirety or in part and it may not be used for advertising. The client to whom the report is issued may, however, show or send it . or a certified copy there of prepared by the Shenzhen Timeway Technology Consulting co.,Ltd to his customer. Supplier or others persons directly concerned. Shenzhen Timeway Technology Consulting co.,Ltd will not, without the consent of the client enter into any discussion of correspondence with any third party concerning the contents of the report.
In the event of the improper use of the report. The Shenzhen Timeway Technology Consulting co.,Ltd reserves the rights to withdraw it and to adopt any other remedies which may be appropriate.

Outside View



The report refers only to the sample tested and does not apply to the bulk.
This report is issued in confidence to the client and it will be strictly treated as such by the Shenzhen Timeway Technology Consulting Co.,Ltd. It may not be reproduced rather in its entirety or in part and it may not be used for advertising. The client to whom the report is issued may, however, show or send it or a certified copy thereof prepared by the Shenzhen Timeway Technology Consulting Co.,Ltd to his customer. Supplier or other persons directly concerned. Shenzhen Timeway Technology Consulting Co.,Ltd will not, without the consent of the client enter into any discussion of correspondence with any third party concerning the contents of the report.
In the event of the improper use of the report. The Shenzhen Timeway Technology Consulting Co.,Ltd reserves the rights to withdraw it and to adopt any other remedies which may be appropriate.

Outside View



The report refers only to the sample tested and does not apply to the bulk.
This report is issued in confidence to the client and it will be strictly treated as such by the Shenzhen Timeway Technology Consulting Co.,Ltd. It may not be reproduced rather in its entirety or in part and it may not be used for advertising. The client to whom the report is issued may, however, show or send it . or a certified copy there of prepared by the Shenzhen Timeway Technology Consulting co.,Ltd to his customer. Supplier or others persons directly concerned. Shenzhen Timeway Technology Consulting co.,Ltd will not, without the consent of the client enter into any discussion of correspondence with any third party concerning the contents of the report.
In the event of the improper use of the report. The Shenzhen Timeway Technology Consulting co.,Ltd reserves the rights to withdraw it and to adopt any other remedies which may be appropriate.

Outside View



The report refers only to the sample tested and does not apply to the bulk.
This report is issued in confidence to the client and it will be strictly treated as such by the Shenzhen Timeway Technology Consulting Co.,Ltd. It may not be reproduced rather in its entirety or in part and it may not be used for advertising. The client to whom the report is issued may, however, show or send it . or a certified copy there of prepared by the Shenzhen Timeway Technology Consulting co.,Ltd to his customer. Supplier or others persons directly concerned. Shenzhen Timeway Technology Consulting co.,Ltd will not, without the consent of the client enter into any discussion of correspondence with any third party concerning the contents of the report.
In the event of the improper use of the report. The Shenzhen Timeway Technology Consulting co.,Ltd reserves the rights to withdraw it and to adopt any other remedies which may be appropriate.

Outside View



The report refers only to the sample tested and does not apply to the bulk.

This report is issued in confidence to the client and it will be strictly treated as such by the Shenzhen Timeway Technology Consulting Co., Ltd. It may not be reproduced rather in its entirety or in part and it may not be used for advertising. The client to whom the report is issued may, however, show or send it, or a certified copy thereof prepared by the Shenzhen Timeway Technology Consulting Co., Ltd. to his customer, supplier or other persons directly concerned. Shenzhen Timeway Technology Consulting Co., Ltd. will not, without the consent of the client, enter into any discussion of correspondence with any third party concerning the contents of the report.

In the event of the improper use of the report, the Shenzhen Timeway Technology Consulting Co., Ltd. reserves the rights to withdraw it and to adopt any other remedies which may be appropriate.

Interior View



The report refers only to the sample tested and does not apply to the bulk.
This report is issued in confidence to the client and it will be strictly treated as such by the Shenzhen Timeway Technology Consulting Co., Ltd. It may not be reproduced in its entirety or in part and it may not be used for advertising. The client to whom the report is issued may, however, show or send it, or a certified copy thereof prepared by the Shenzhen Timeway Technology Consulting Co., Ltd. to his customer, supplier or other persons directly concerned. Shenzhen Timeway Technology Consulting Co., Ltd. will not, without the consent of the client, enter into any discussion of correspondence with any third party concerning the contents of the report.
In the event of the improper use of the report, the Shenzhen Timeway Technology Consulting Co., Ltd. reserves the rights to withdraw it and to adopt any other remedies which may be appropriate.

Interior View



The report refers only to the sample tested and does not apply to the bulk.
This report is issued in confidence to the client and it will be strictly treated as such by the Shenzhen Timeway Technology Consulting Co.,Ltd. It may not be reproduced rather in its entirety or in part and it may not be used for advertising. The client to whom the report is issued may, however, show or send it or a certified copy thereof prepared by the Shenzhen Timeway Technology Consulting Co.,Ltd to his customer. Supplier or other persons directly concerned. Shenzhen Timeway Technology Consulting Co.,Ltd will not, without the consent of the client enter into any discussion of correspondence with any third party concerning the contents of the report.
In the event of the improper use of the report. The Shenzhen Timeway Technology Consulting Co.,Ltd reserves the rights to withdraw it and to adopt any other remedies which may be appropriate.

Interior View



The report refers only to the sample tested and does not apply to the bulk.
This report is issued in confidence to the client and it will be strictly treated as such by the Shenzhen Timeway Technology Consulting Co.,Ltd. It may not be reproduced rather in its entirety or in part and it may not be used for advertising. The client to whom the report is issued may, however, show or send it, or a certified copy thereof prepared by the Shenzhen Timeway Technology Consulting Co.,Ltd to his customer, supplier or other persons directly concerned. Shenzhen Timeway Technology Consulting Co.,Ltd will not, without the consent of the client enter into any discussion of correspondence with any third party concerning the contents of the report.
In the event of the improper use of the report, The Shenzhen Timeway Technology Consulting Co.,Ltd reserves the rights to withdraw it and to adopt any other remedies which may be appropriate.

Li-ion Battery Charger:



The report refers only to the sample tested and does not apply to the bulk.
This report is issued in confidence to the client and it will be strictly treated as such by the Shenzhen Timeway Technology Consulting Co., Ltd. It may not be reproduced in its entirety or in part and it may not be used for advertising. The client to whom the report is issued may, however, show or send it, or a certified copy thereof prepared by the Shenzhen Timeway Technology Consulting Co., Ltd. to his customer, supplier or other persons directly concerned. Shenzhen Timeway Technology Consulting Co., Ltd. will not, without the consent of the client, enter into any discussion of correspondence with any third party concerning the contents of the report.
In the event of the improper use of the report, the Shenzhen Timeway Technology Consulting Co., Ltd. reserves the rights to withdraw it and to adopt any other remedies which may be appropriate.

Adapter:



-End of the report-

The report refers only to the sample tested and does not apply to the bulk.
This report is issued in confidence to the client and it will be strictly treated as such by the Shenzhen Timeway Technology Consulting Co.,Ltd. It may not be reproduced rather in its entirety or in part and it may not be used for advertising. The client to whom the report is issued may, however, show or send it . or a certified copy there of prepared by the Shenzhen Timeway Technology Consulting co.,Ltd to his customer. Supplier or others persons directly concerned. Shenzhen Timeway Technology Consulting co.,Ltd will not, without the consent of the client enter into any discussion of correspondence with any third party concerning the contents of the report.
In the event of the improper use of the report. The Shenzhen Timeway Technology Consulting co.,Ltd reserves the rights to withdraw it and to adopt any other remedies which may be appropriate.